



# NINJAGO

Masters of Spinjitzu

2507



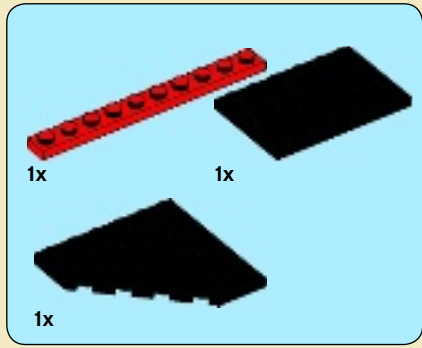

84

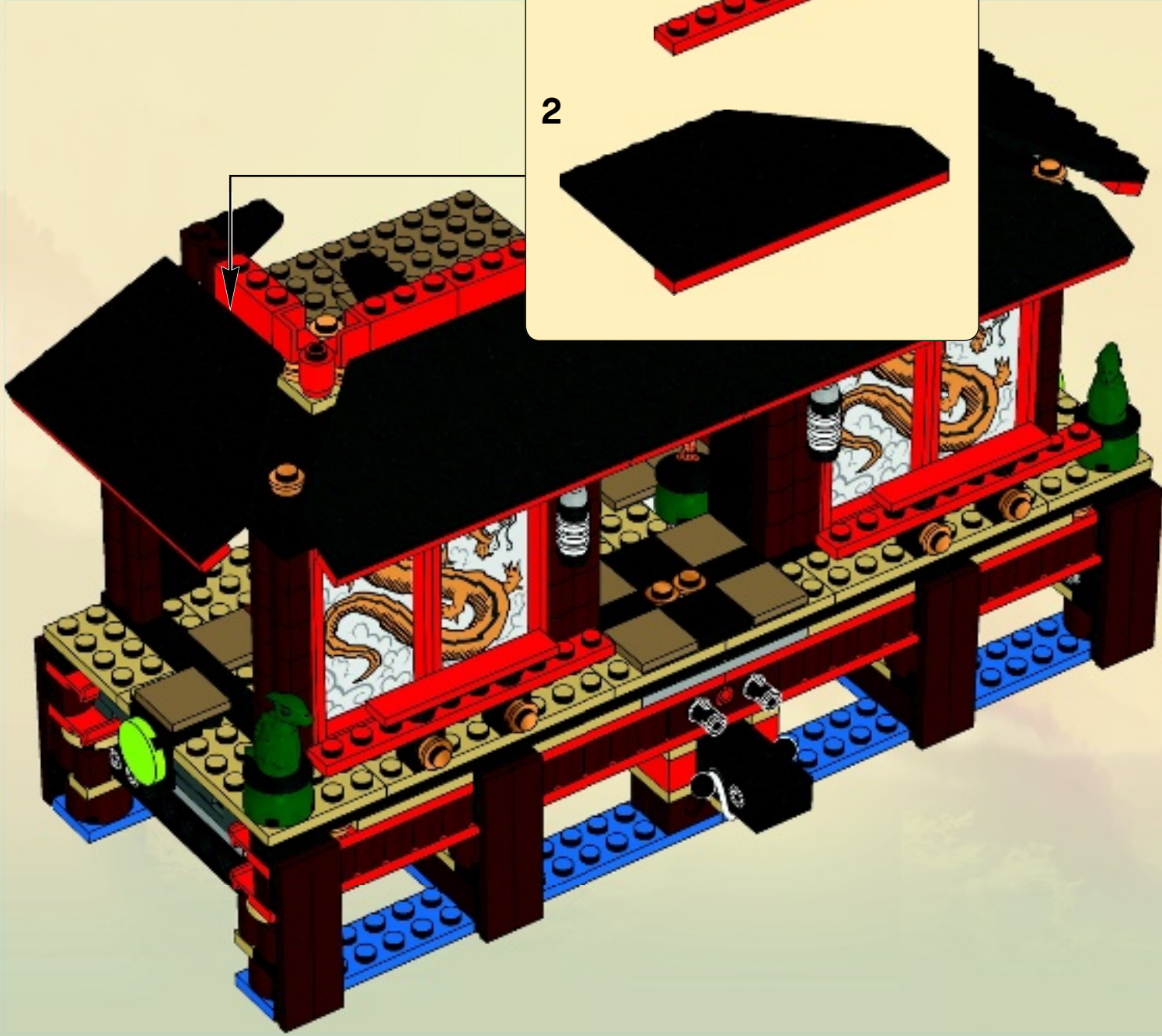
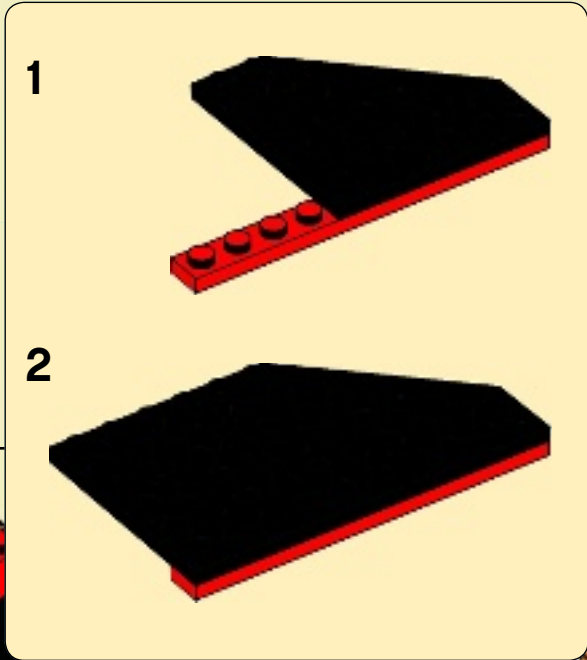



2x



1x

1x

1

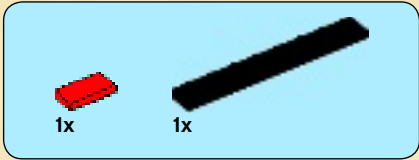

1x

1x

2

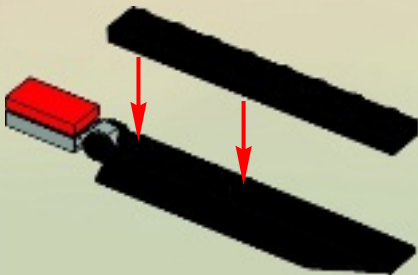

1x

1x

3

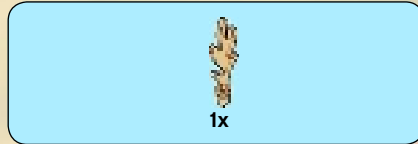

1x

4



2x

85

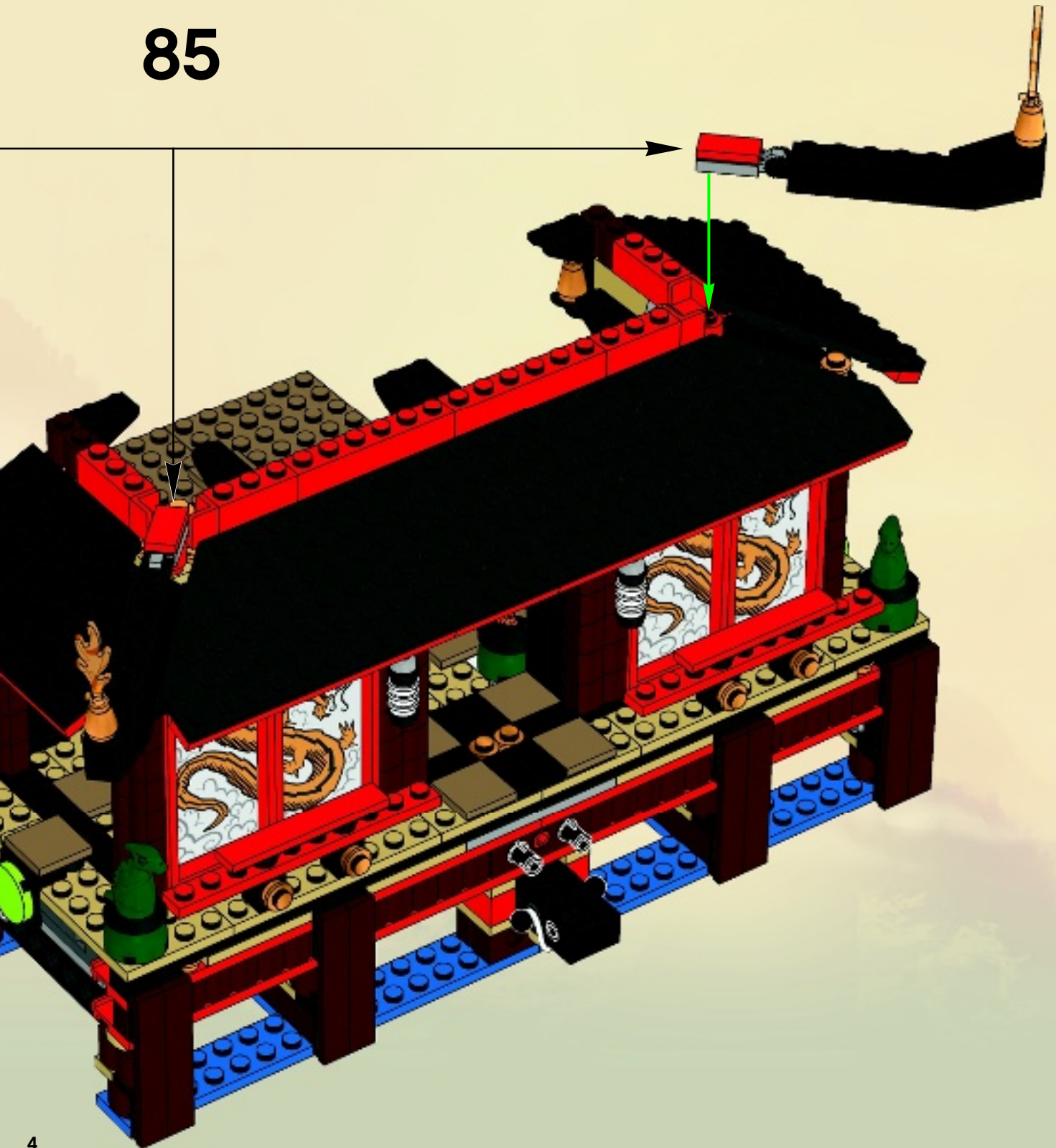



86

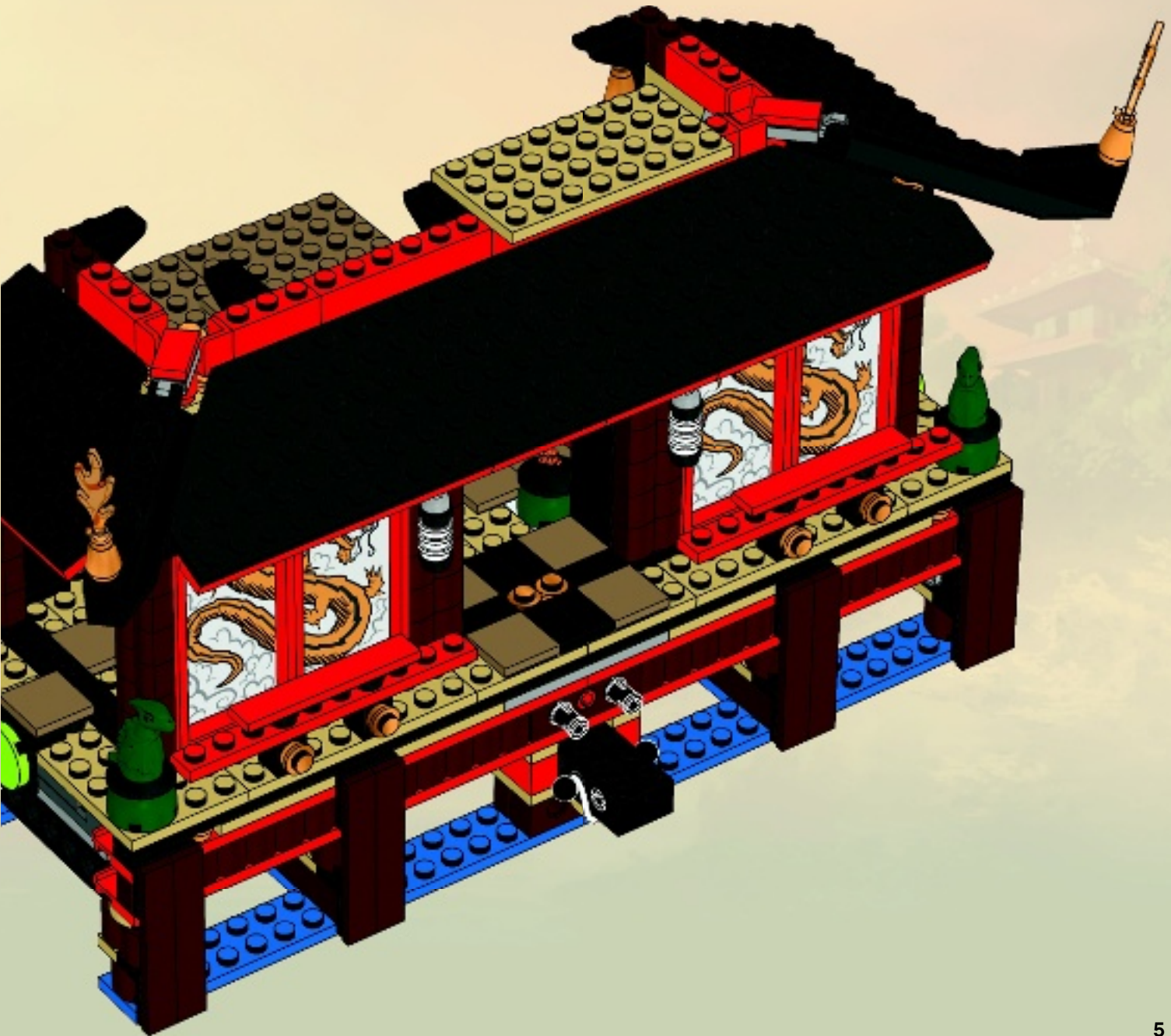

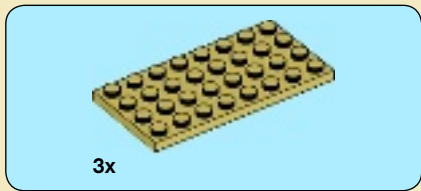

87

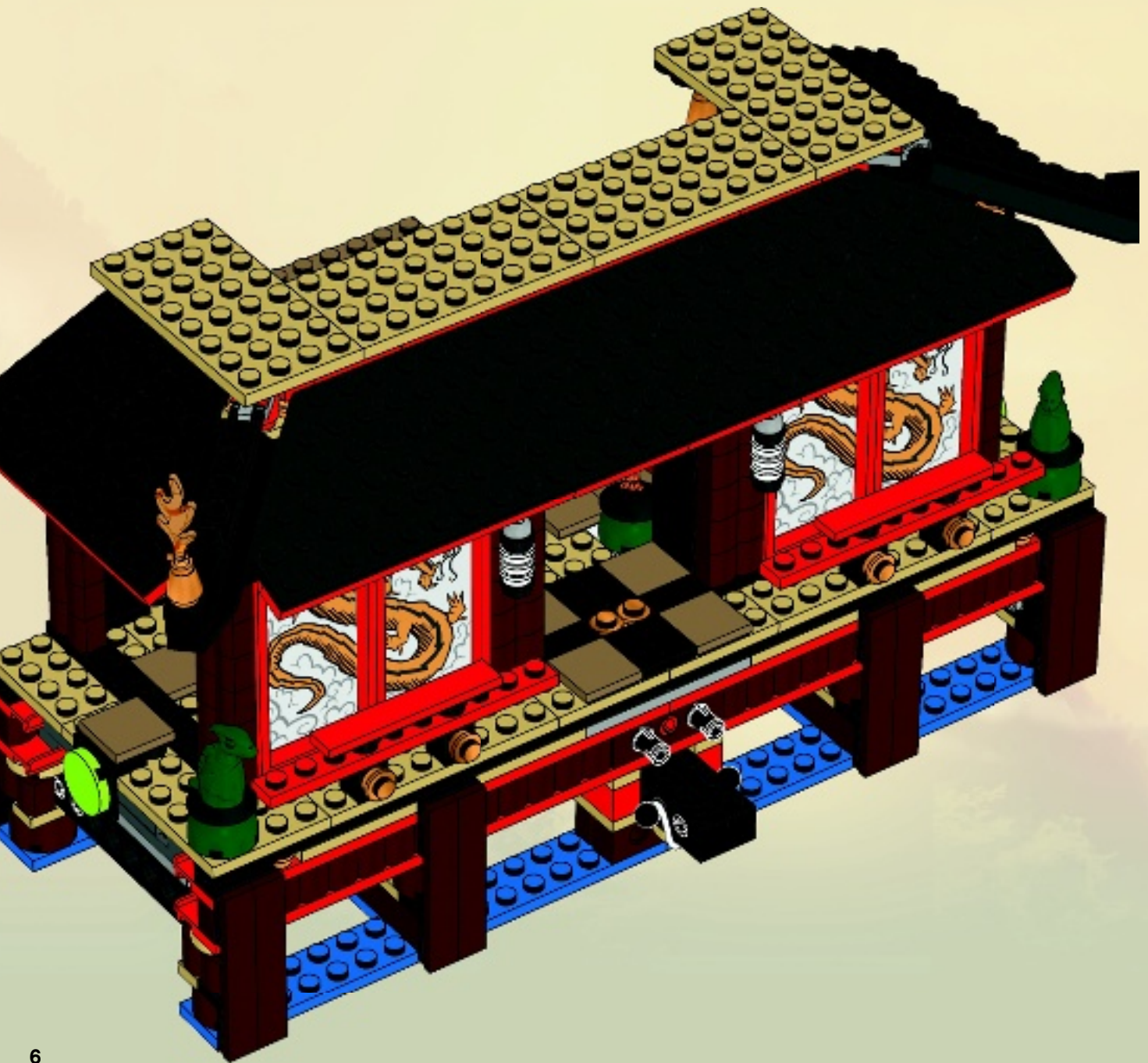

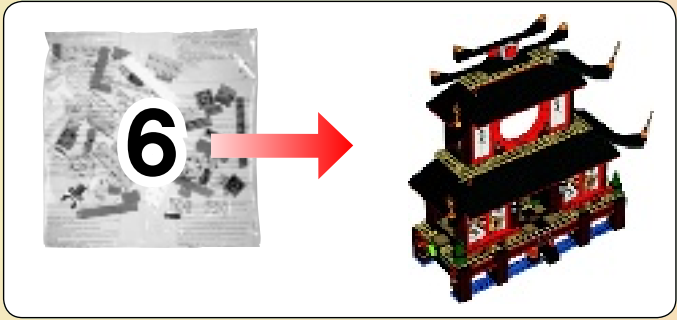

88



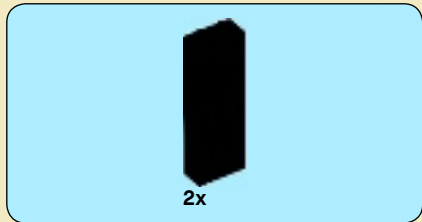

89





12x

90

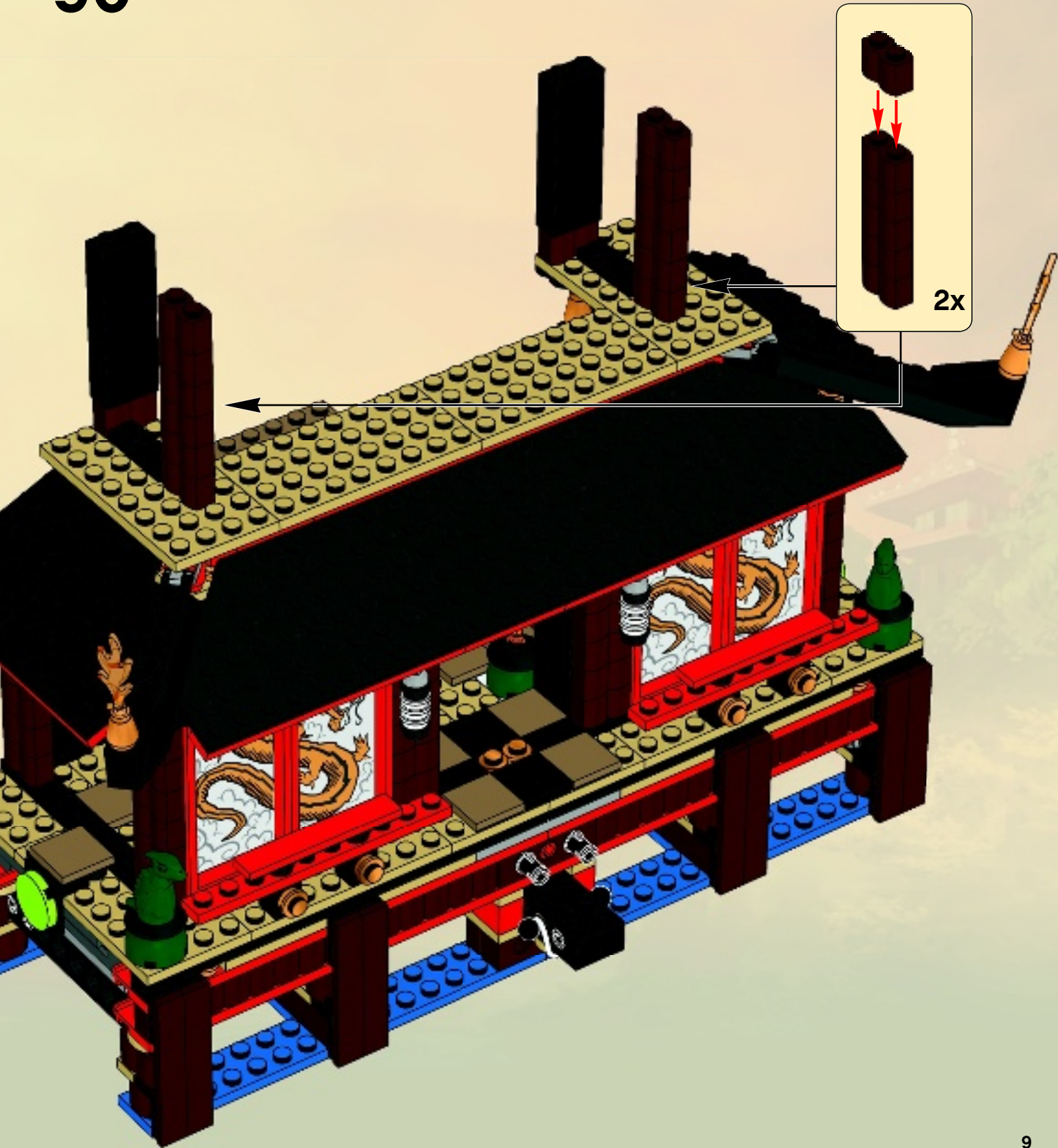

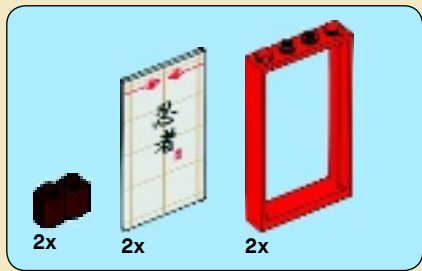

91

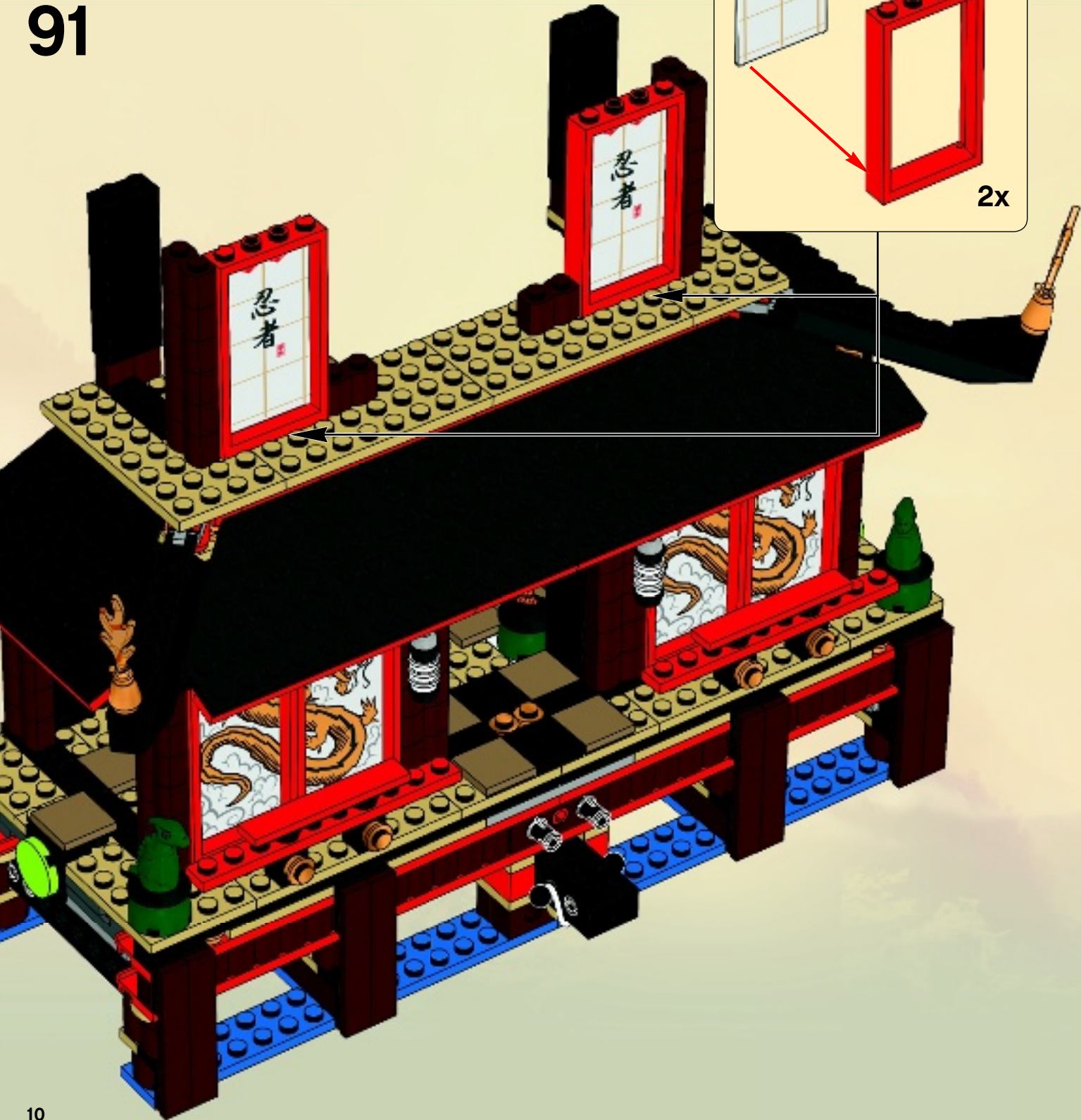
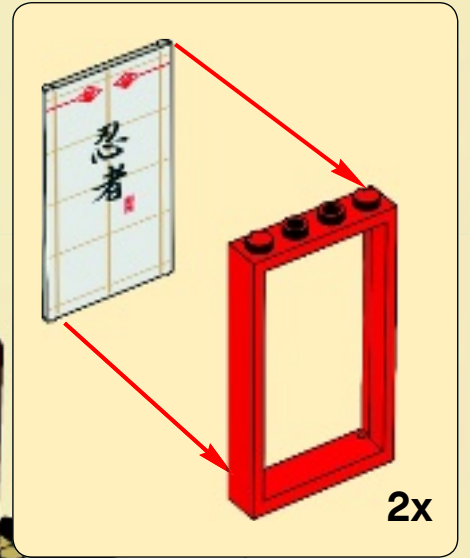



2x



2x

# 92

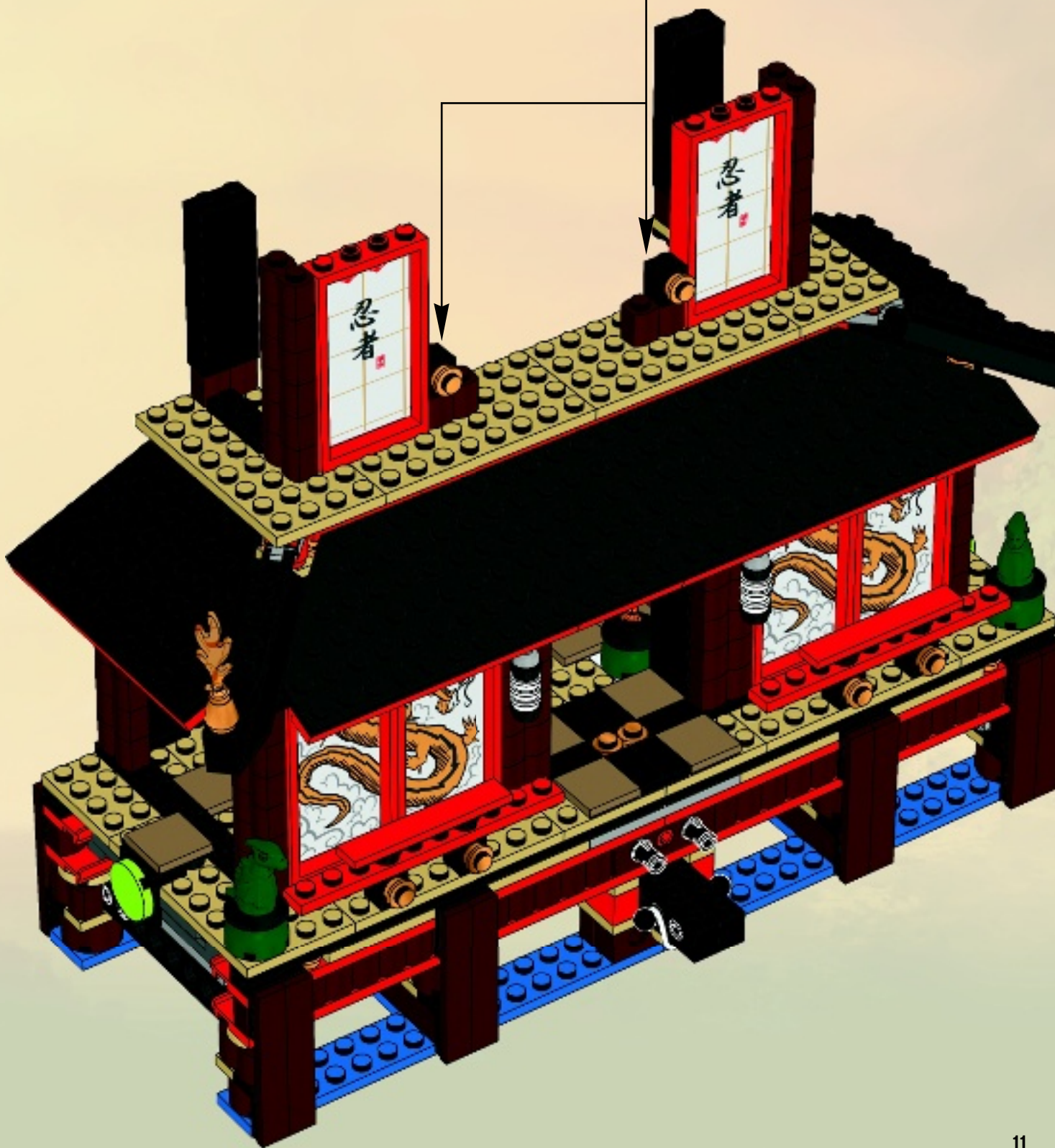
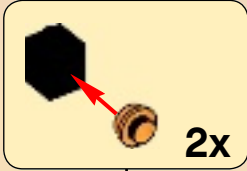

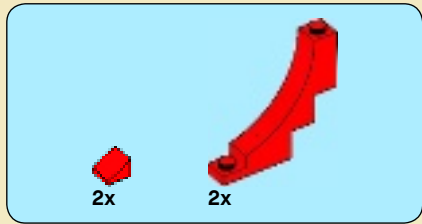

93



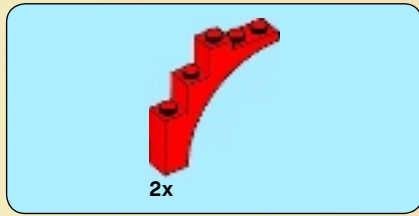

94

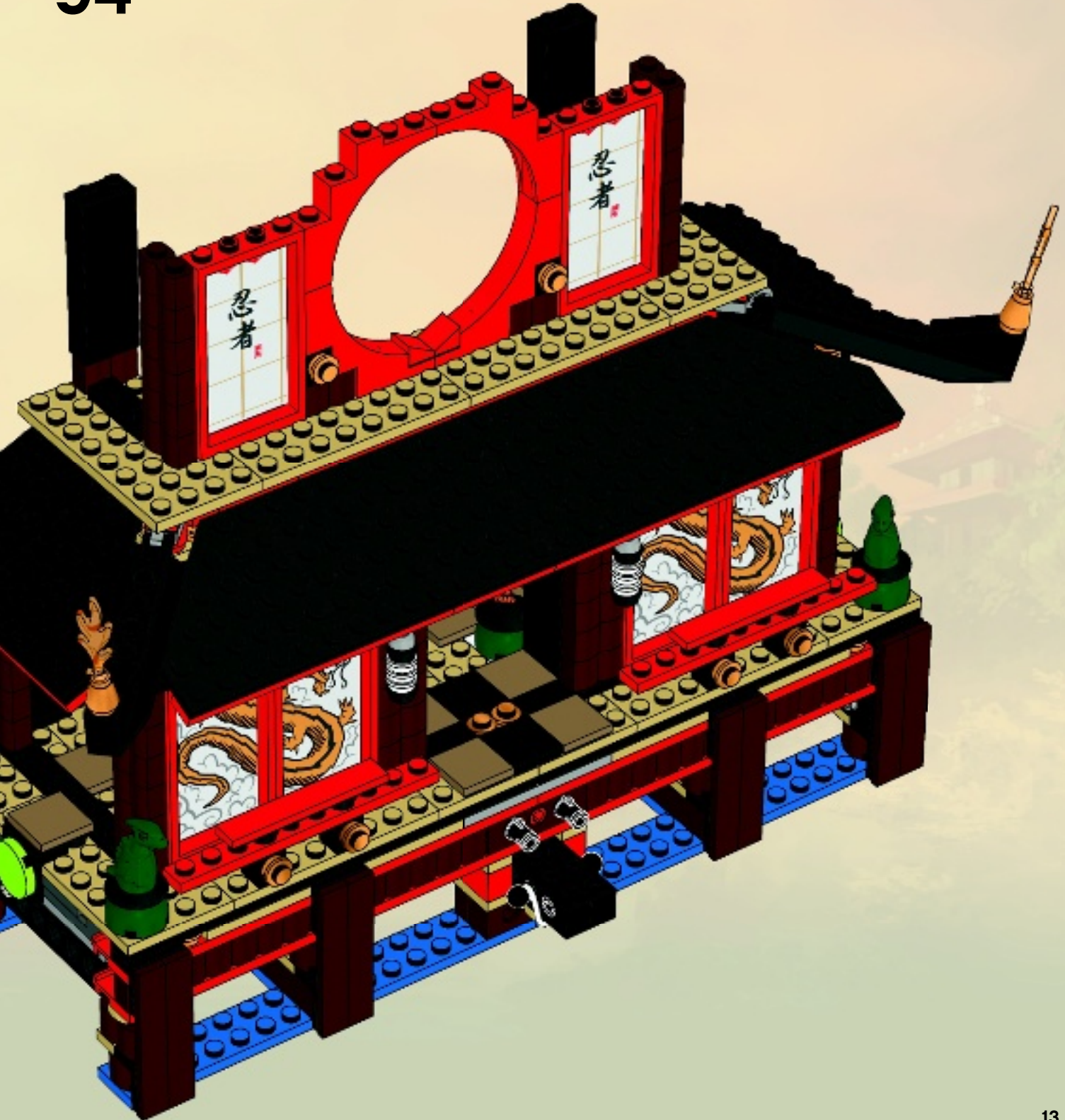



95

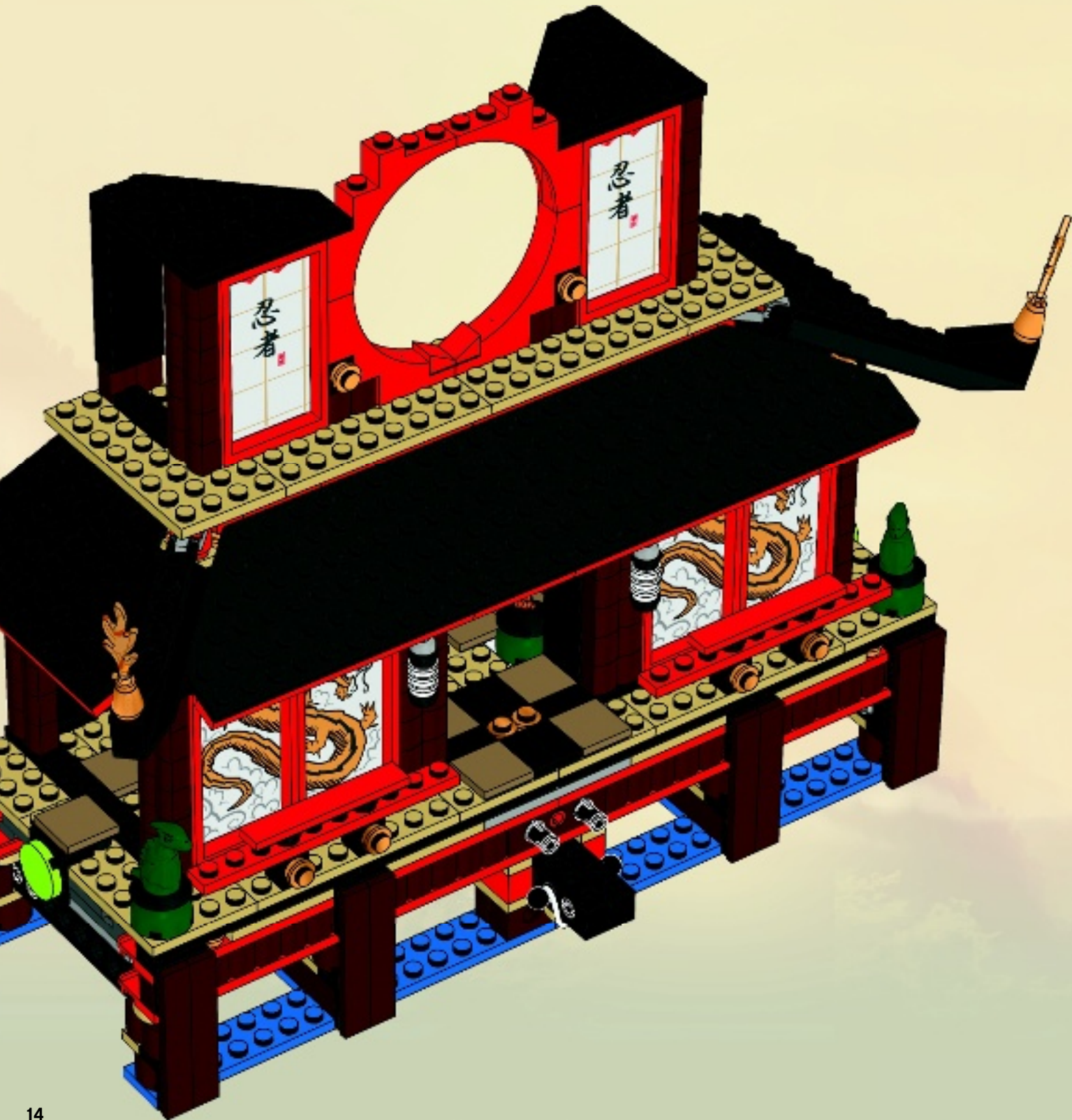

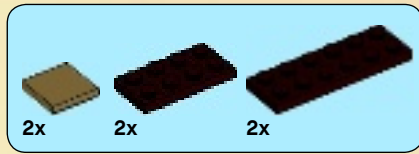

96

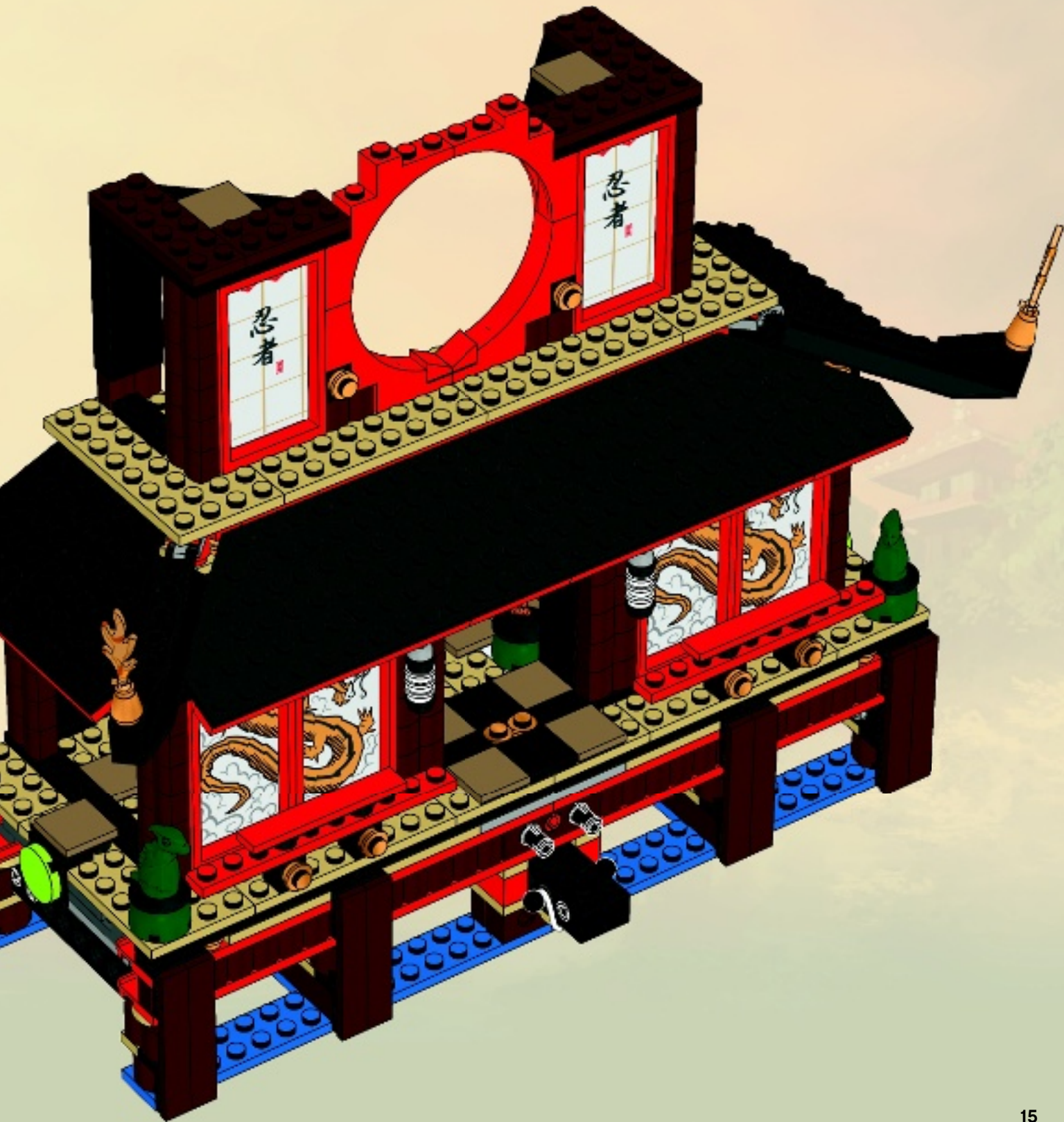

2x  2x 

97

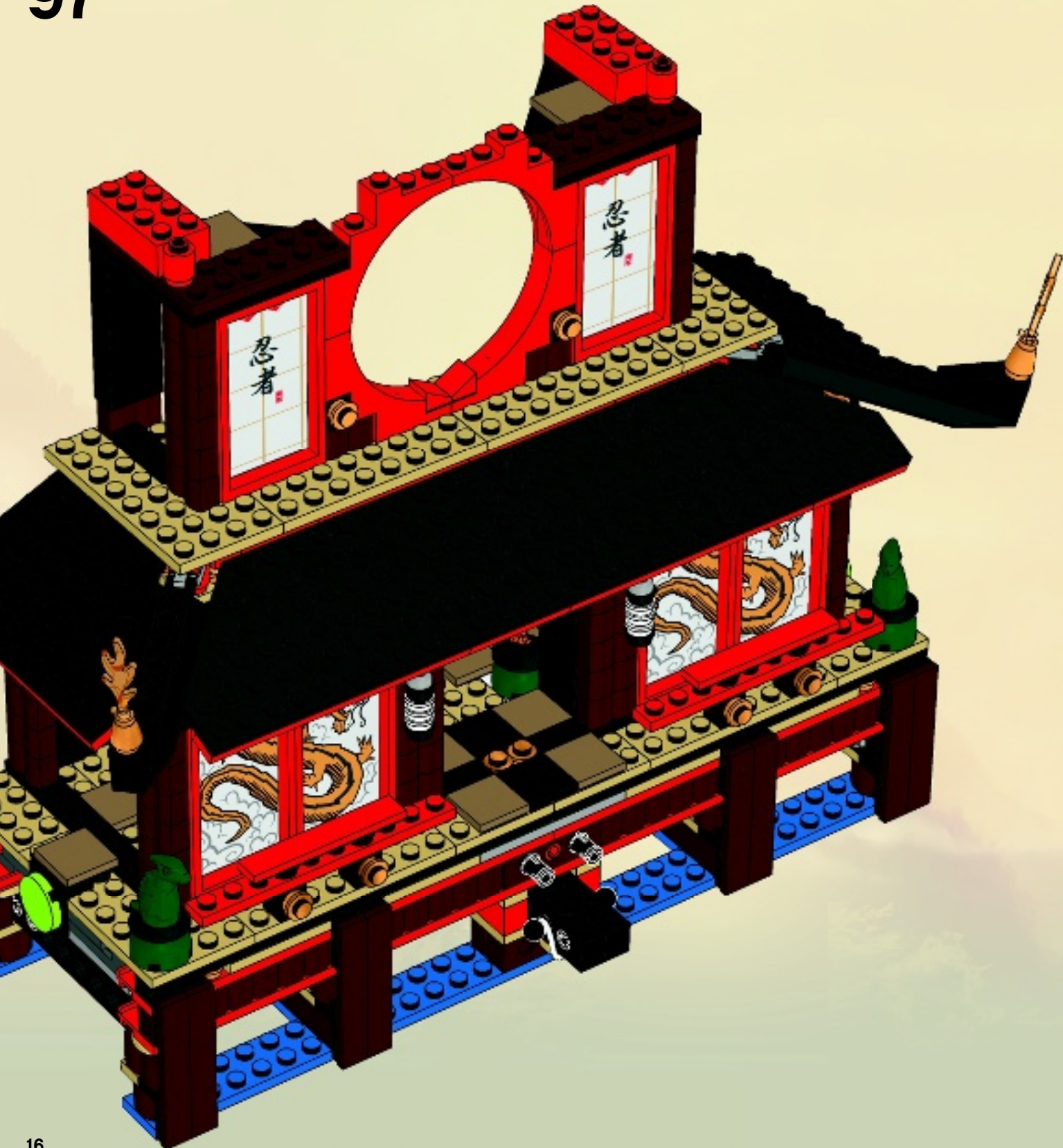



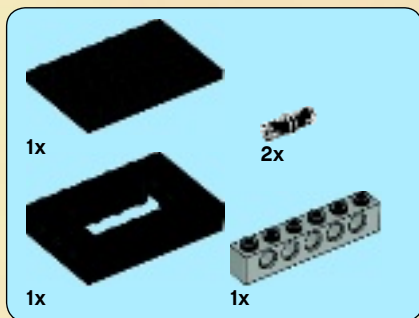

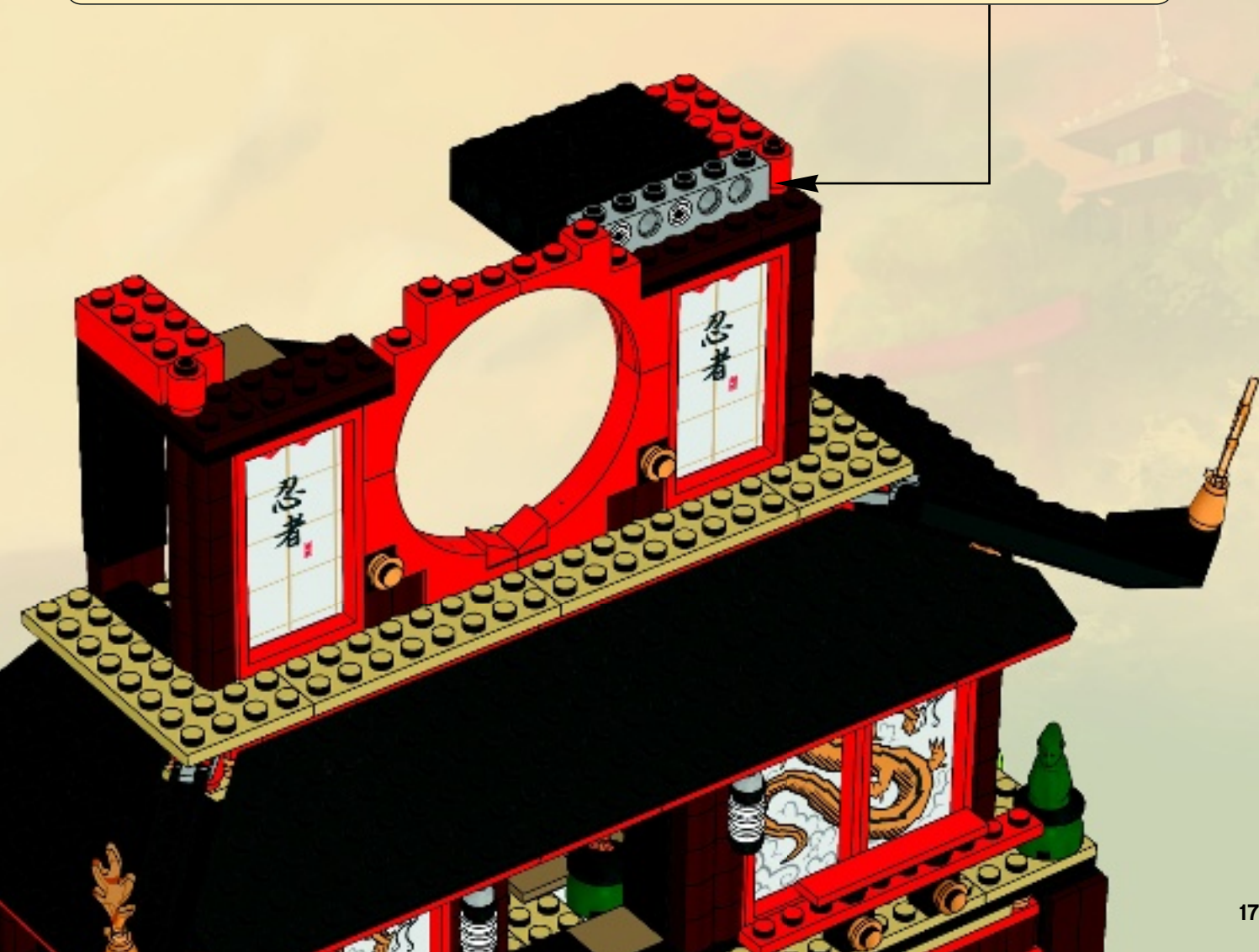
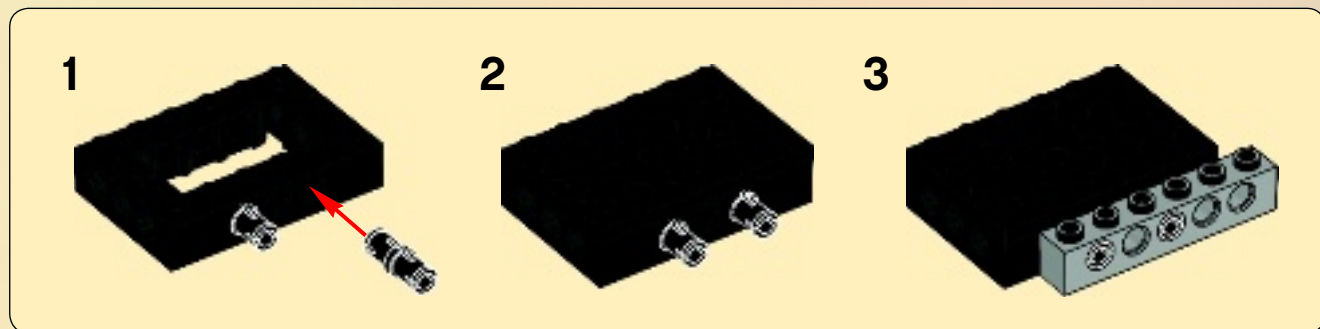

# 98

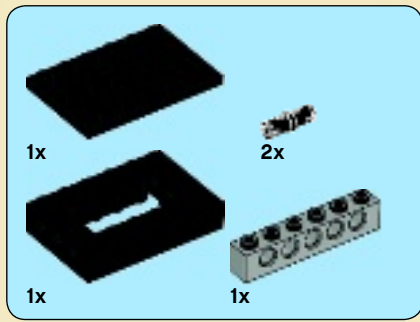



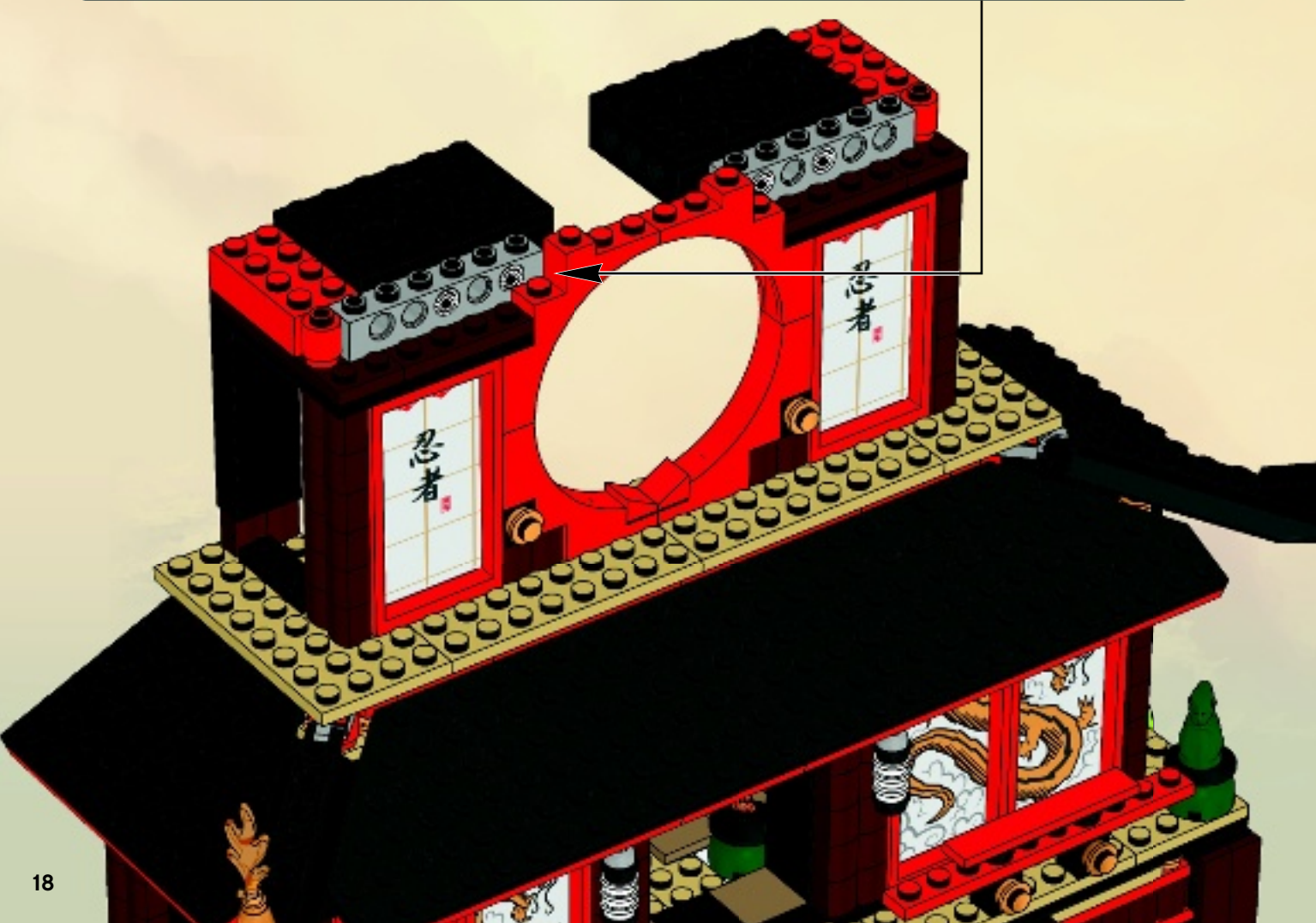
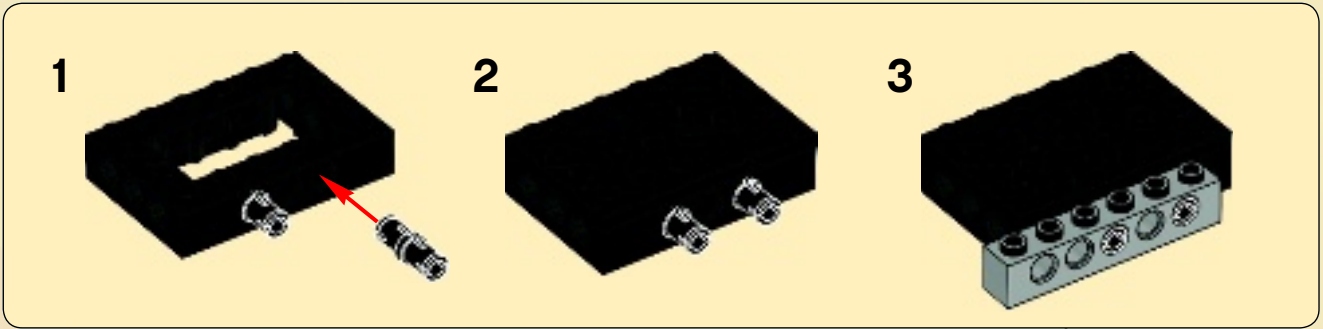

99



2x  4x 

100

  
↓  
 2x

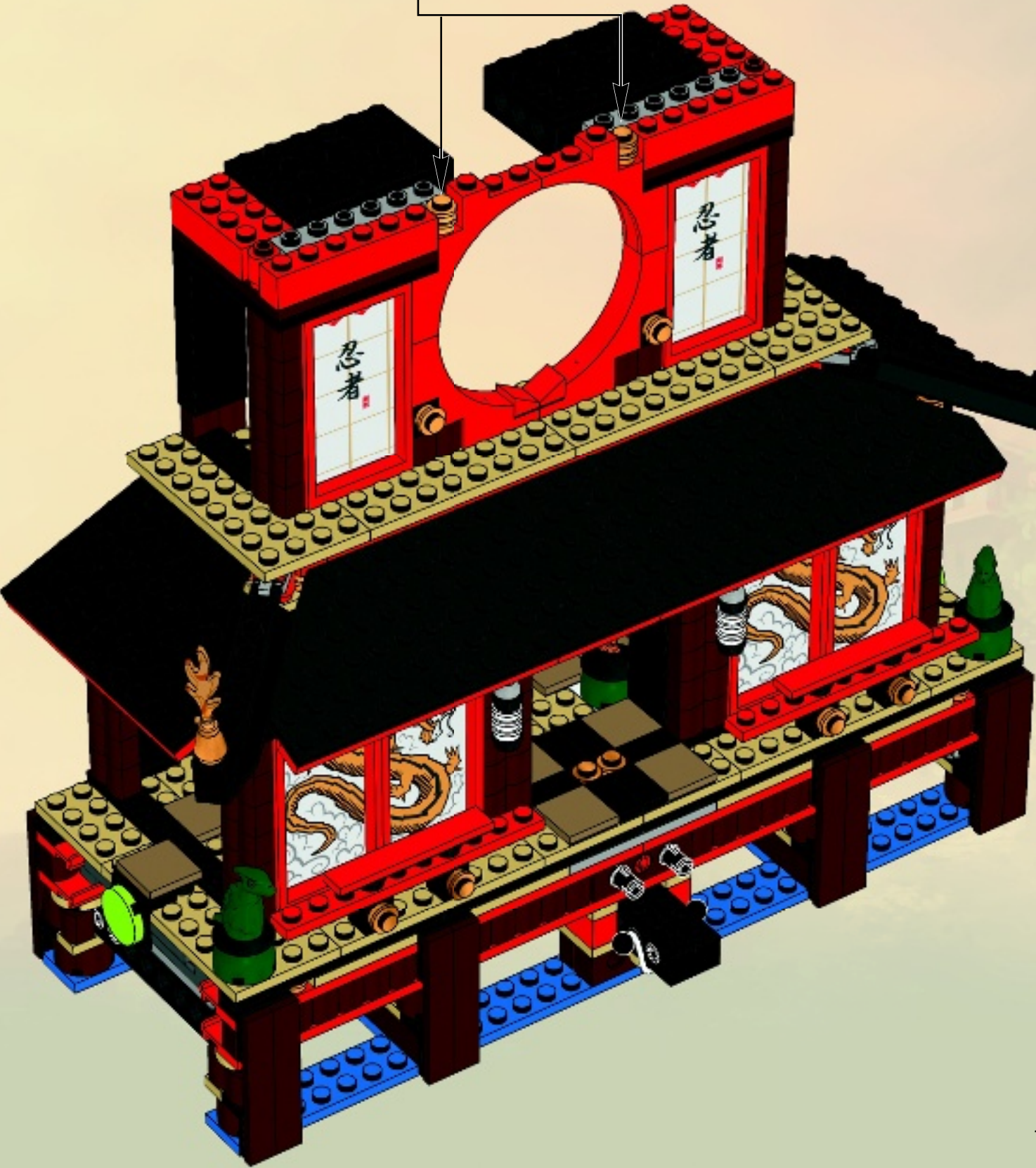



4x

# 101

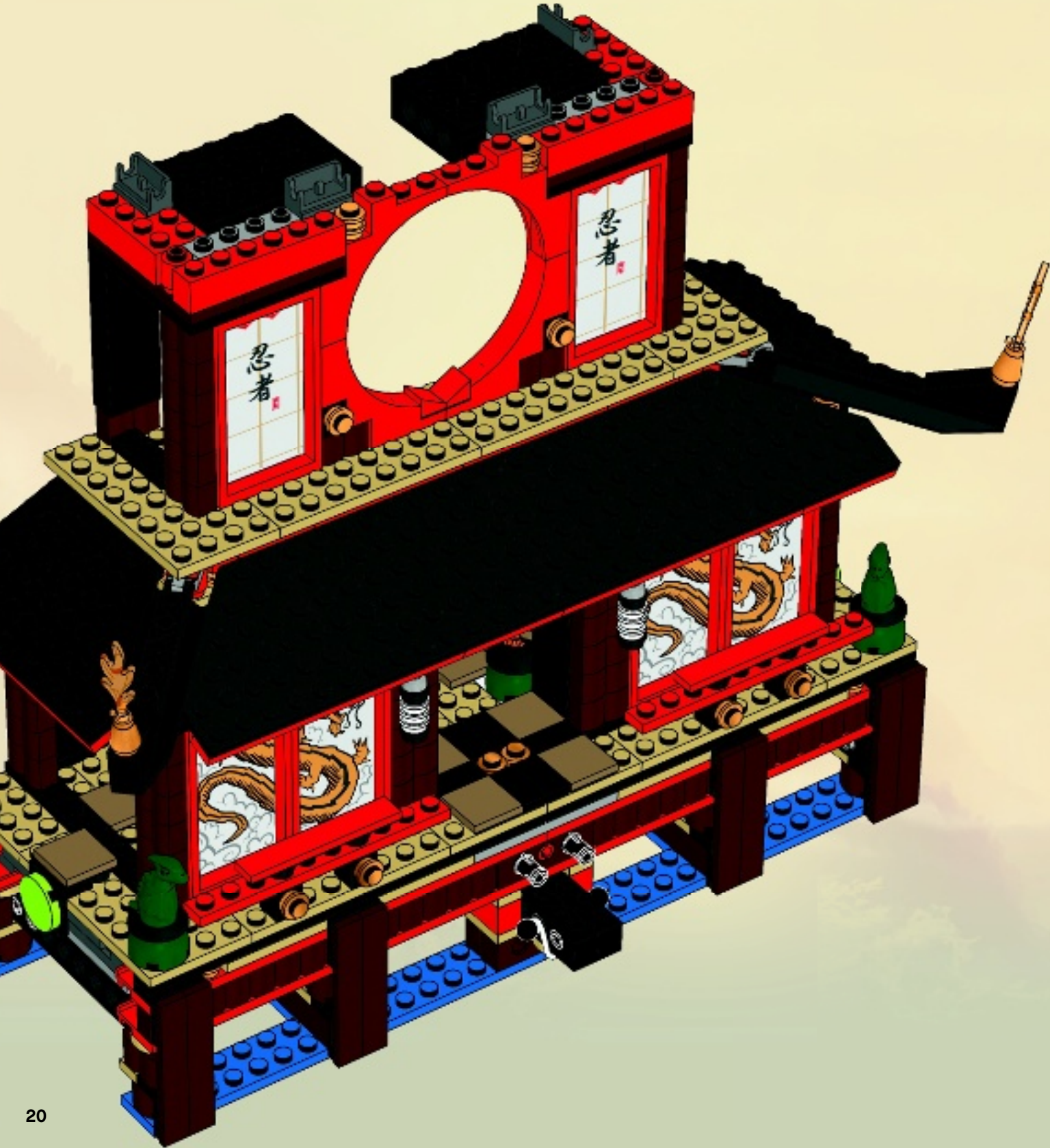



2x



4x

# 102





2x



2x

# 103

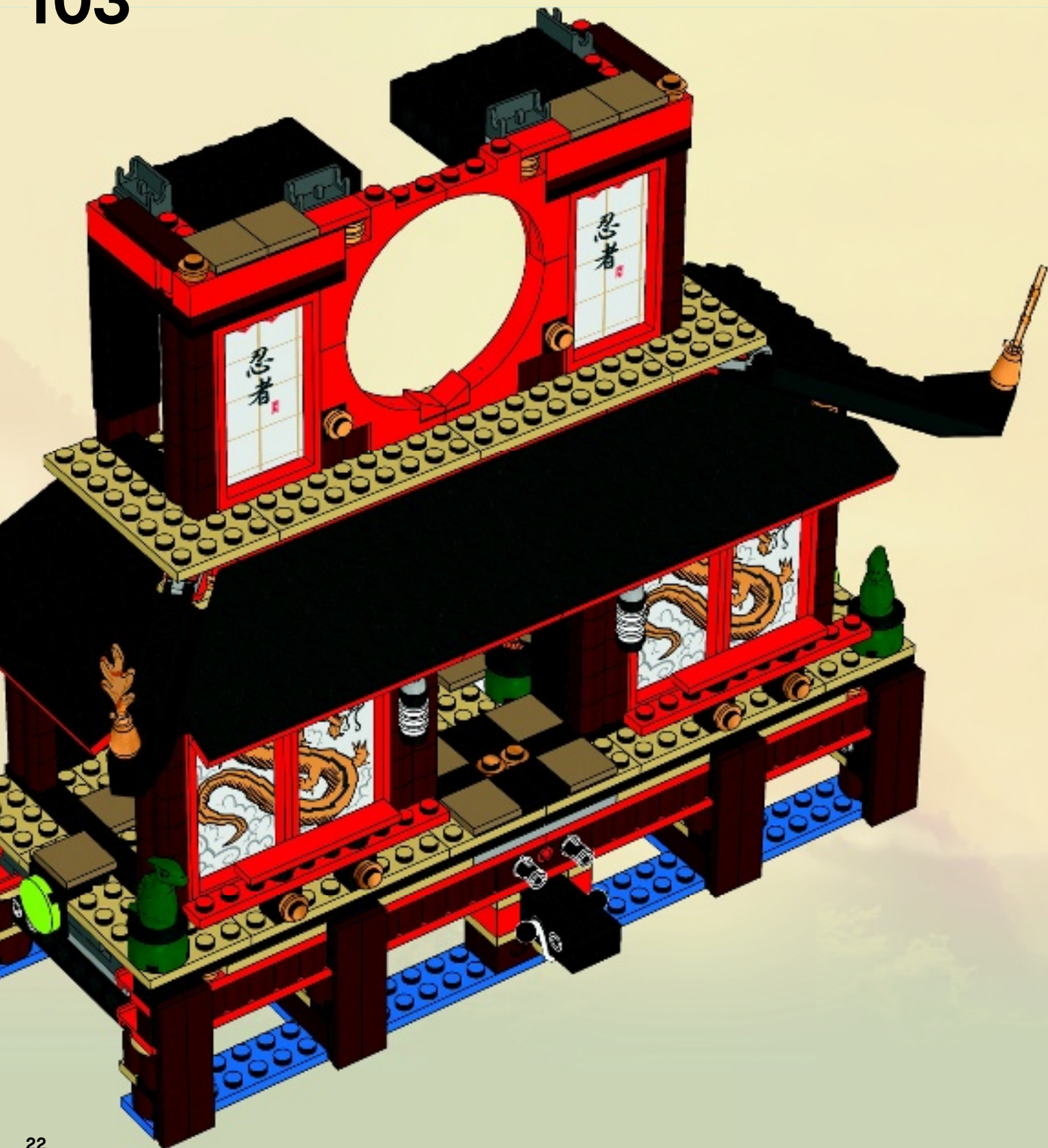





2x

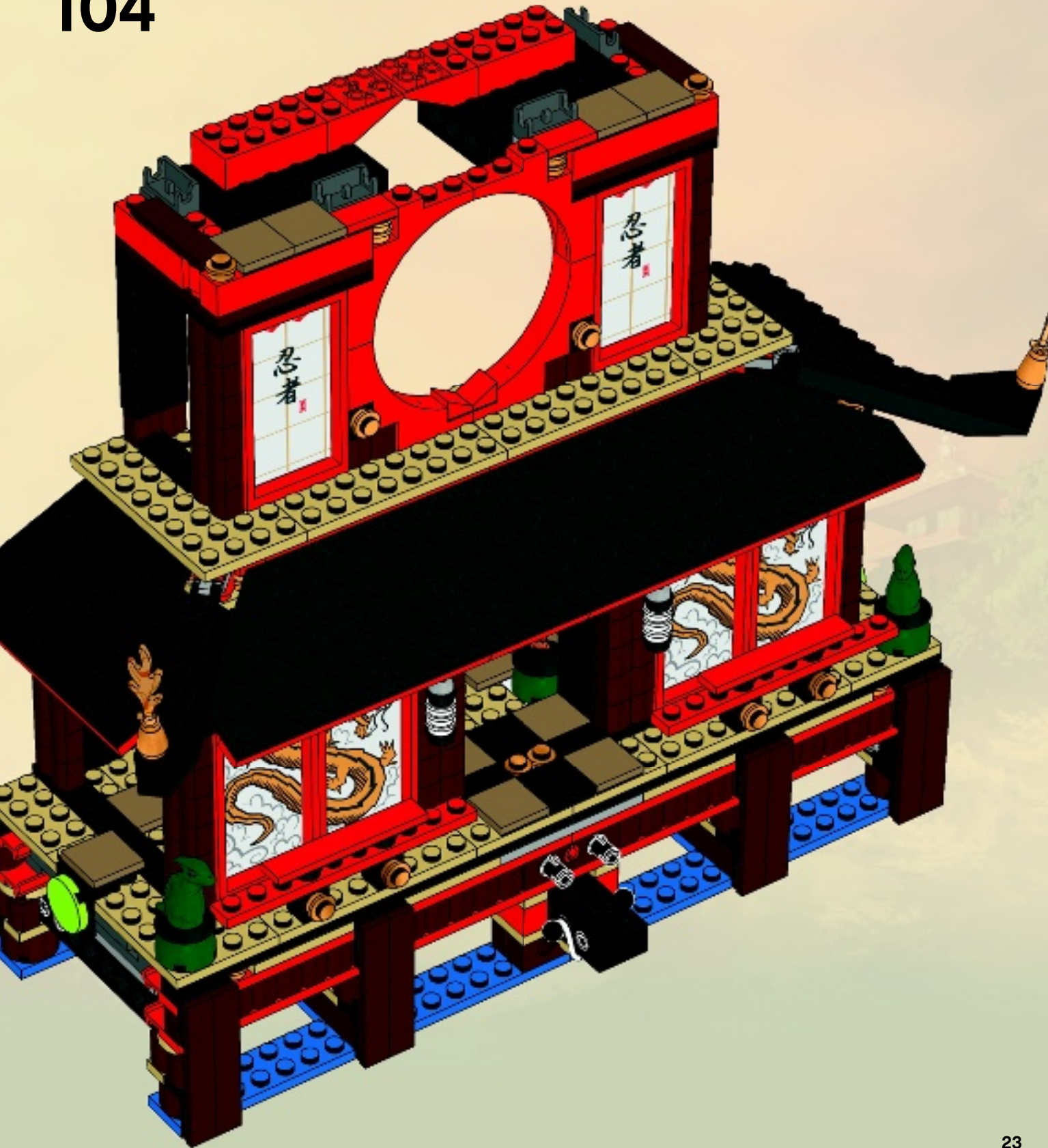

2x

# 104



2x  2x 

# 105







2x



2x

# 106

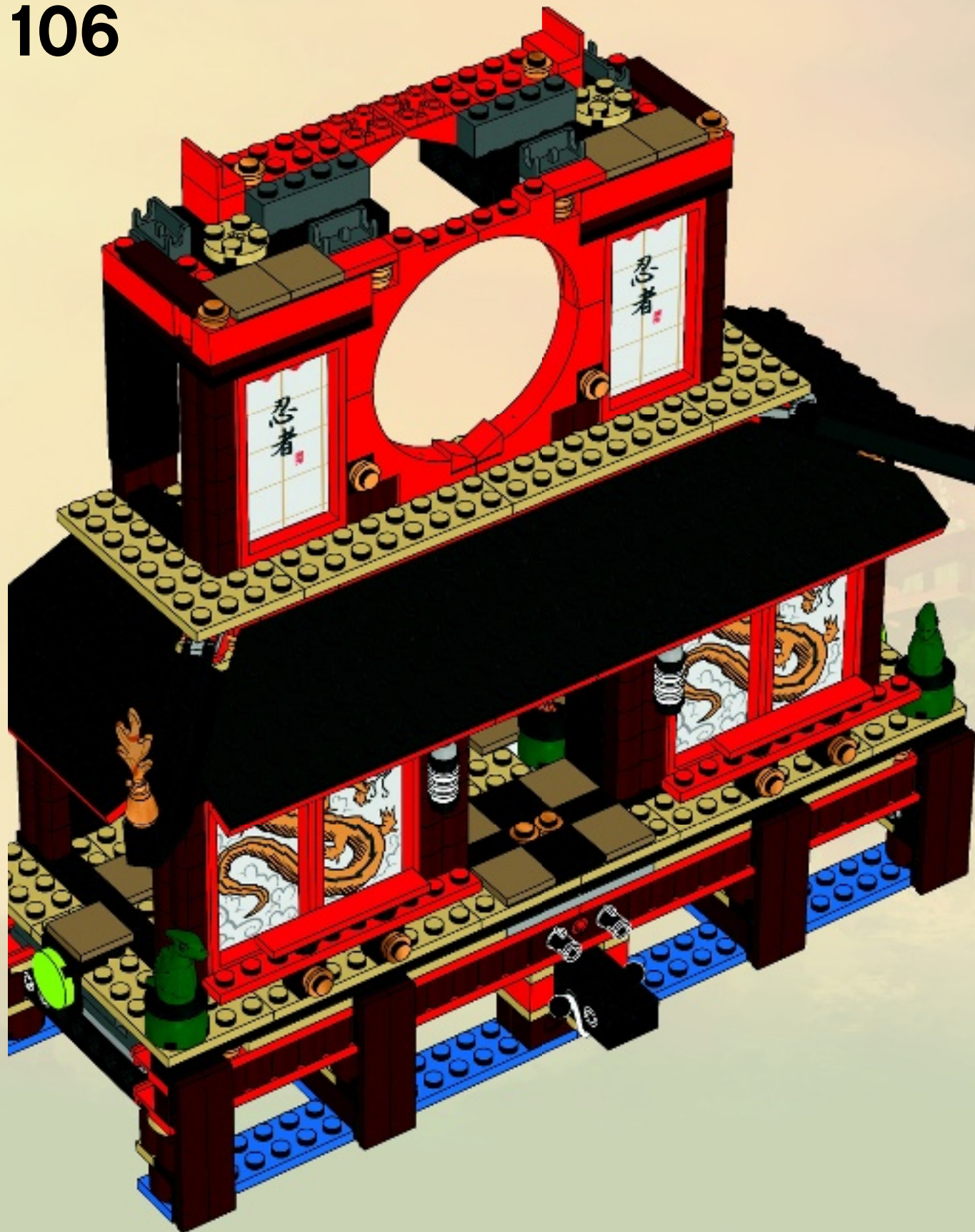

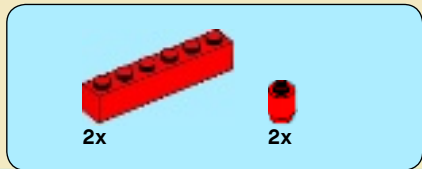

107





# 108

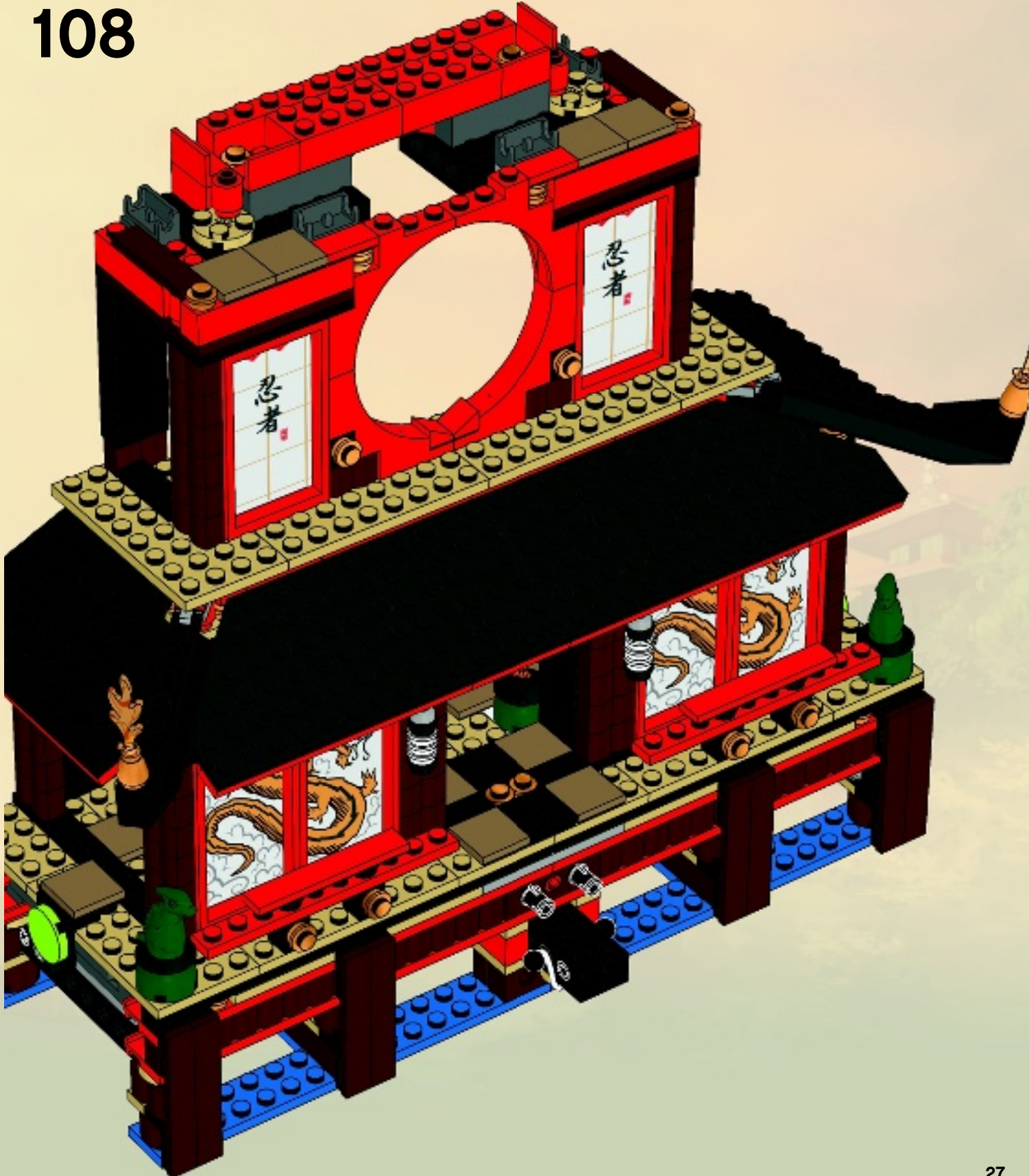

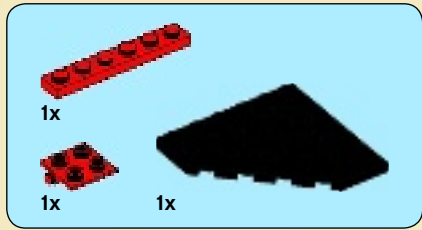

109

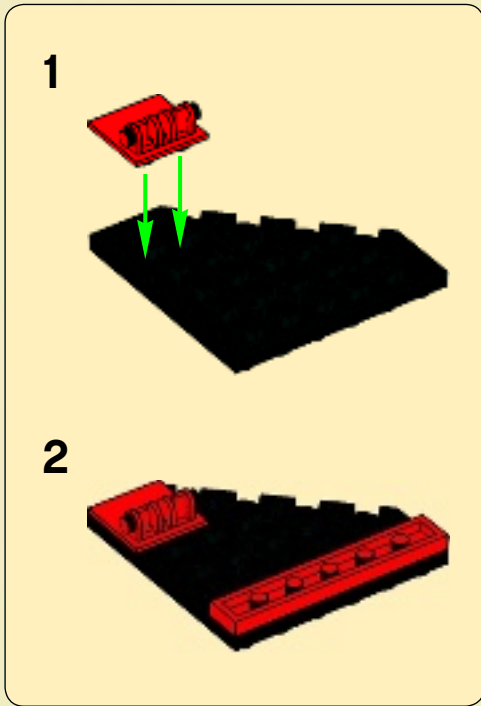

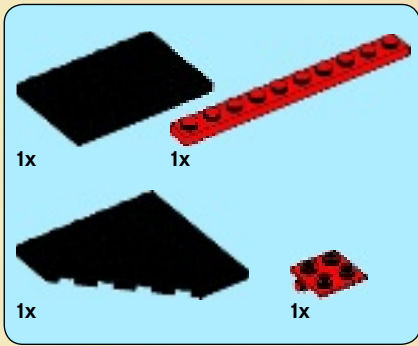

# 110

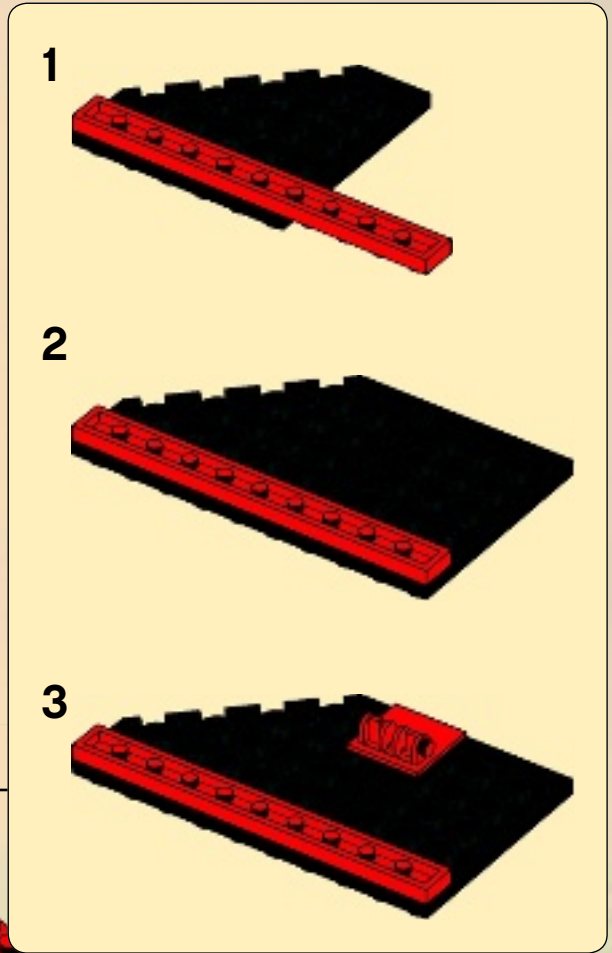

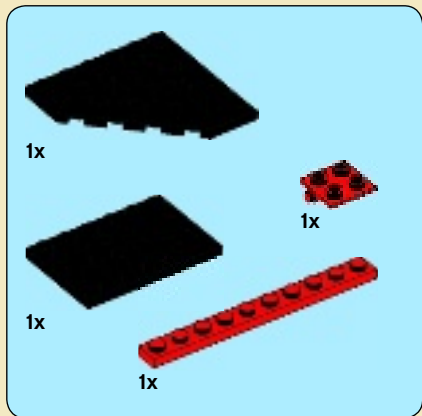

111

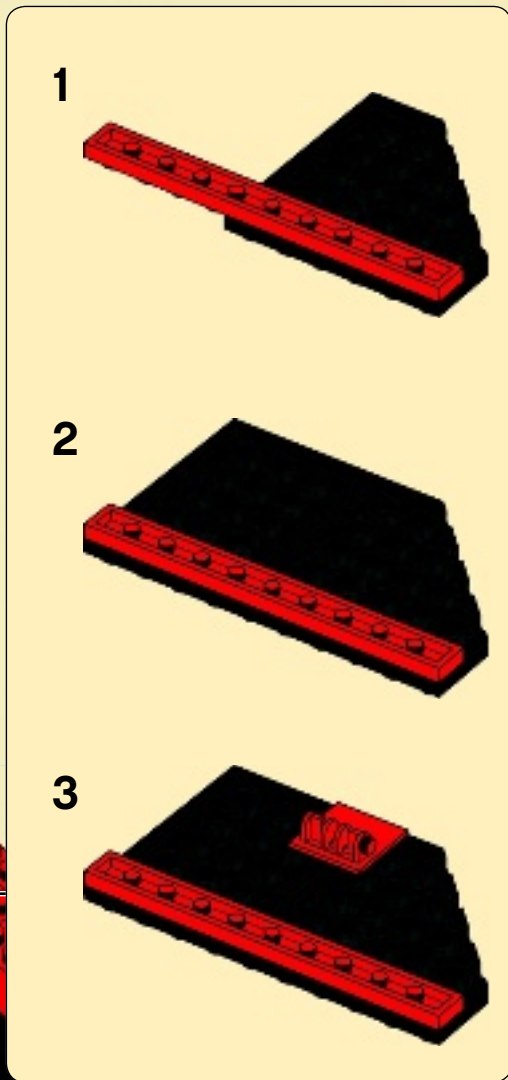

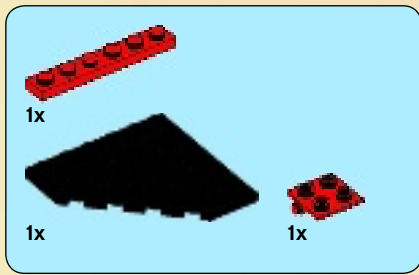

# 112

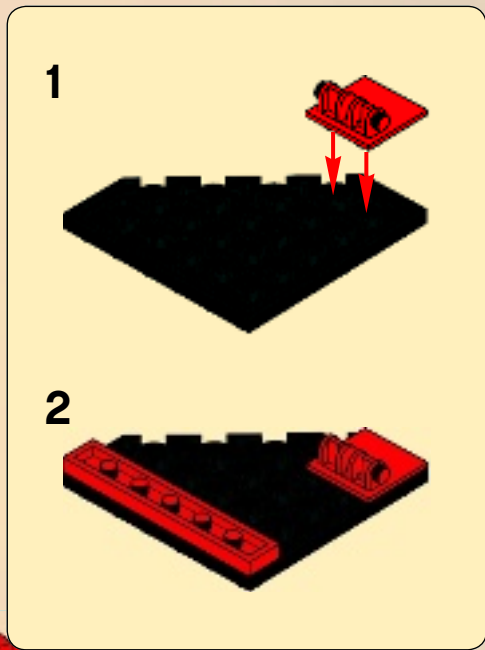

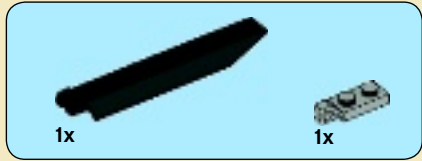
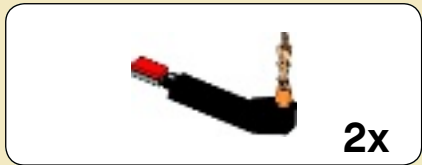

1

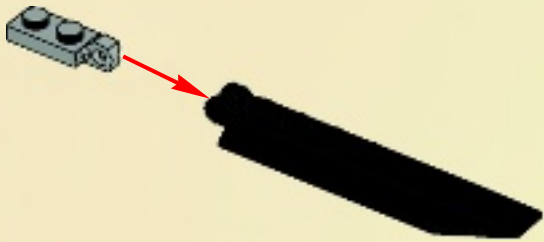

2

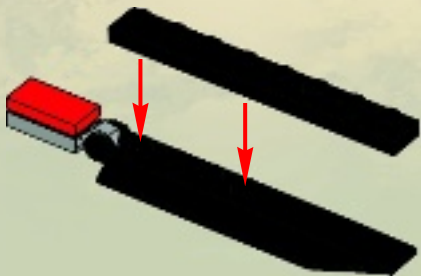

3

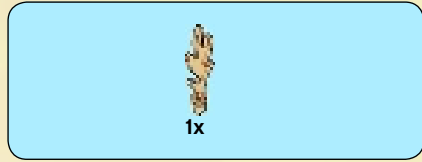

4

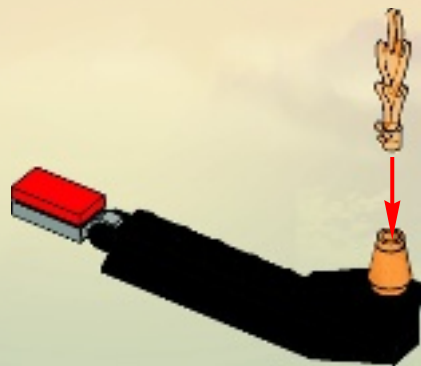

2x



113

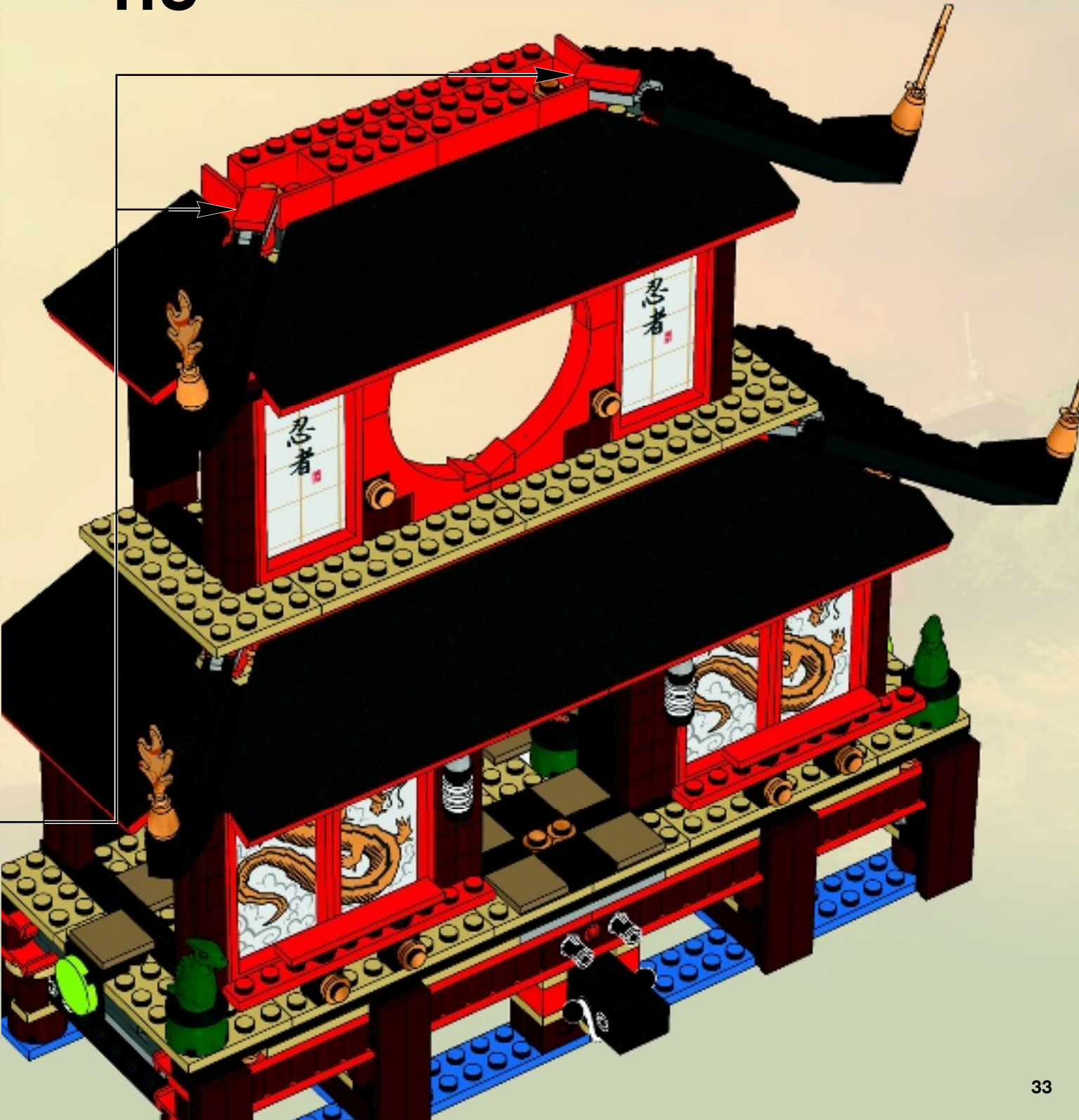

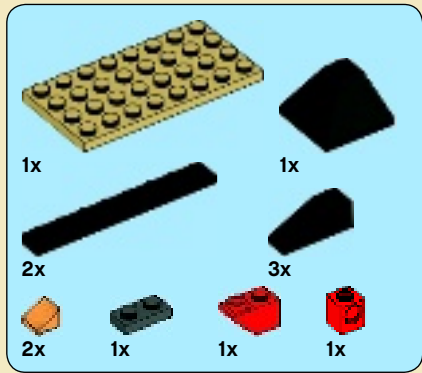

# 114

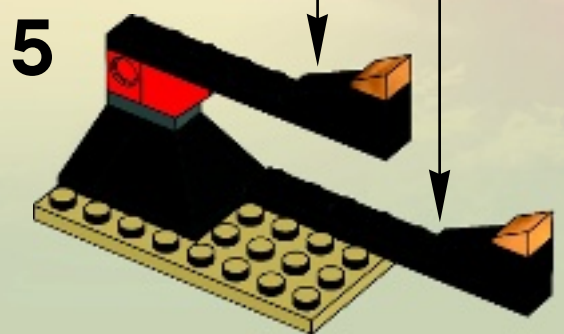
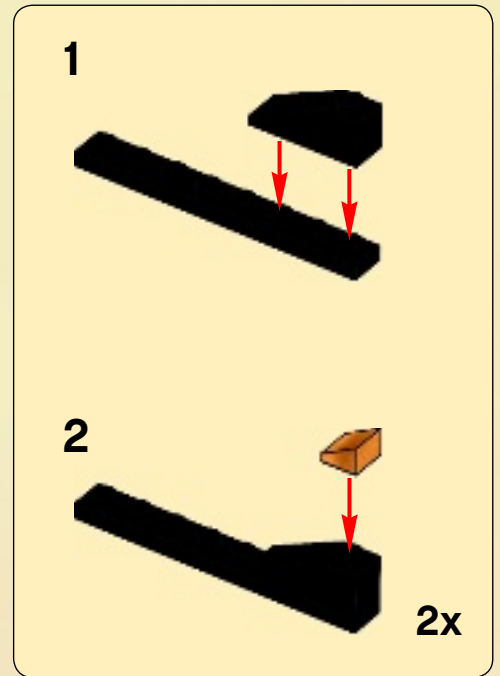
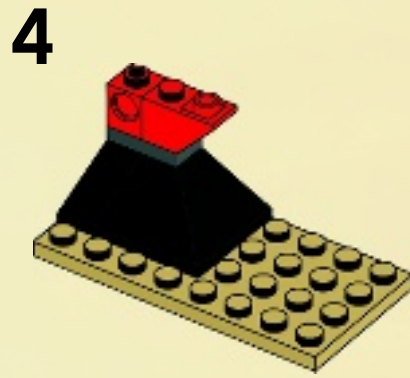
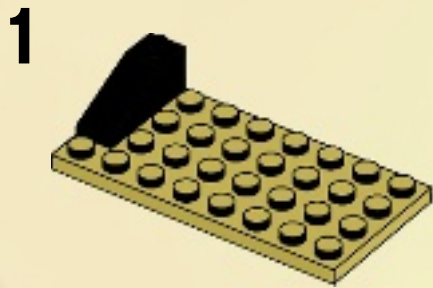

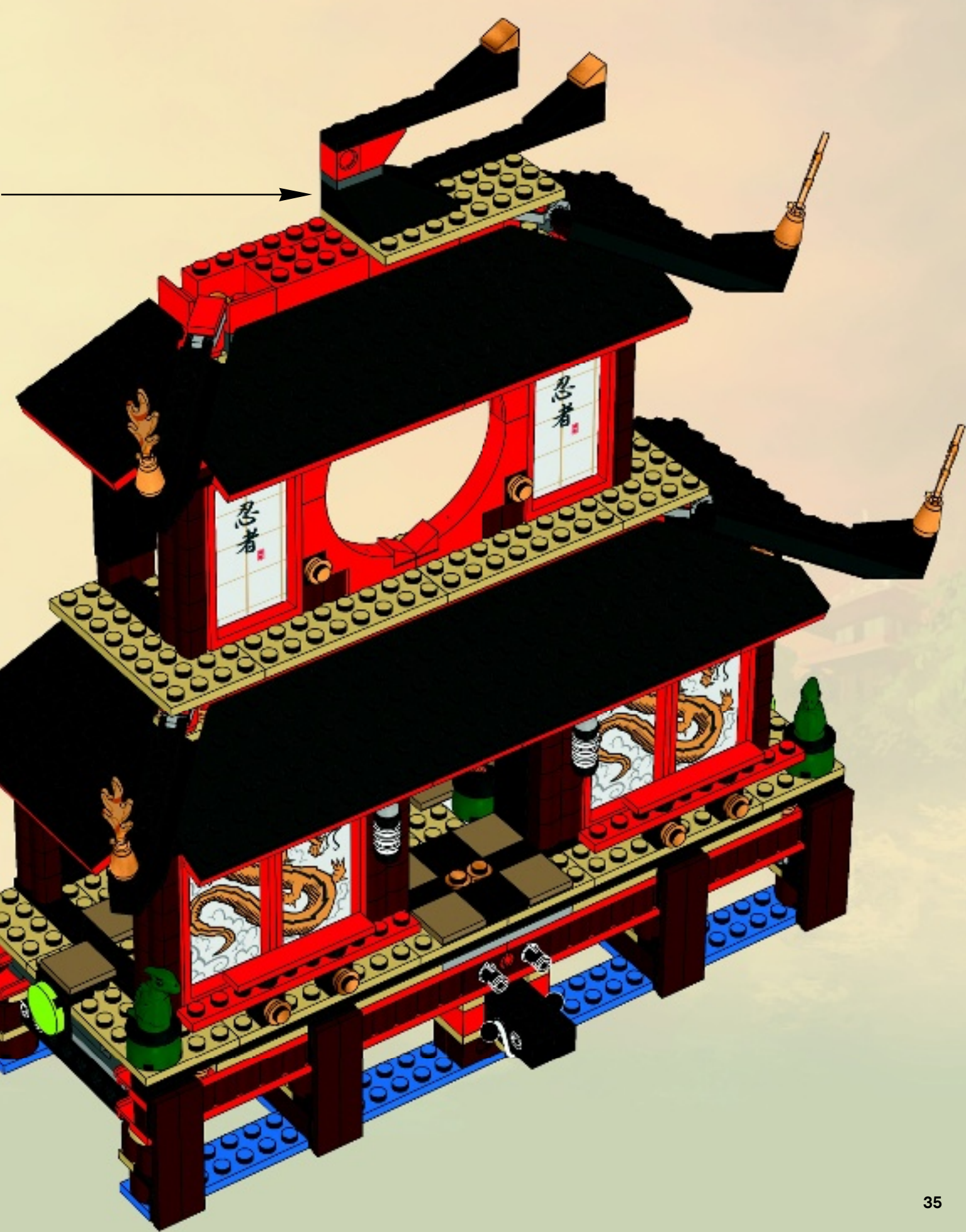

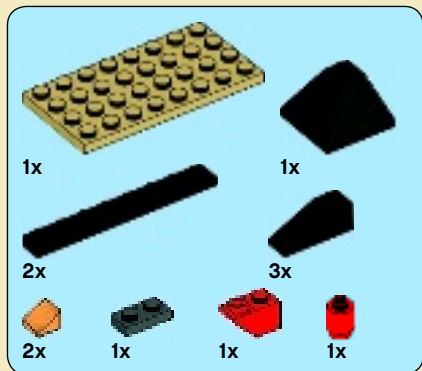

# 115

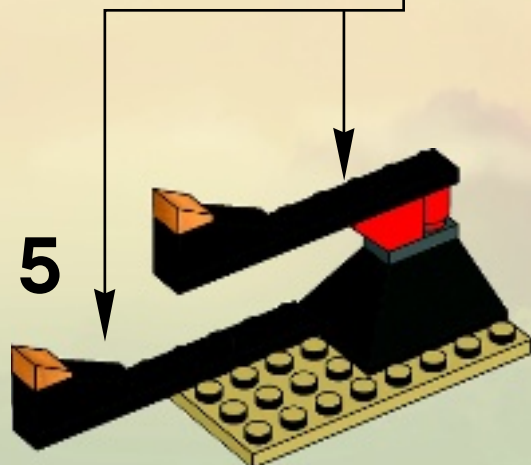
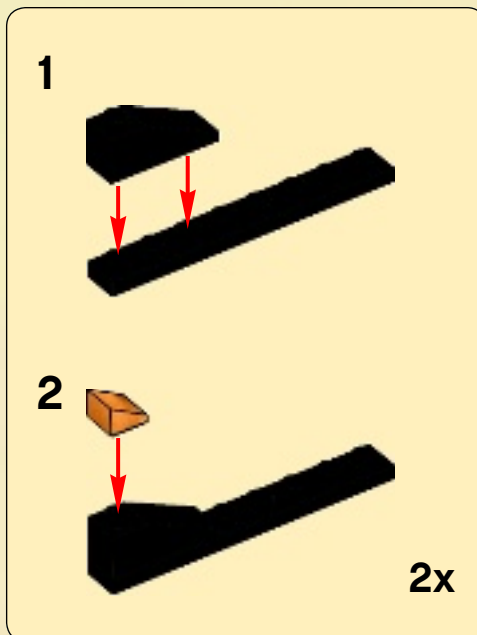
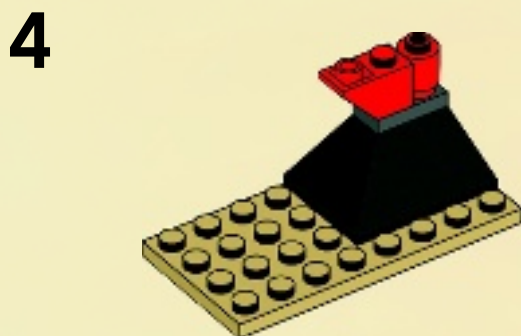
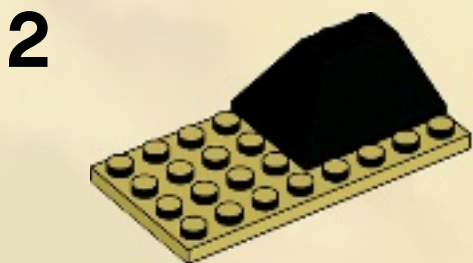



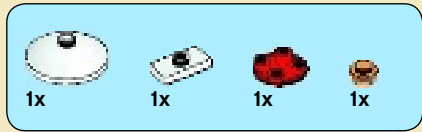

# 116

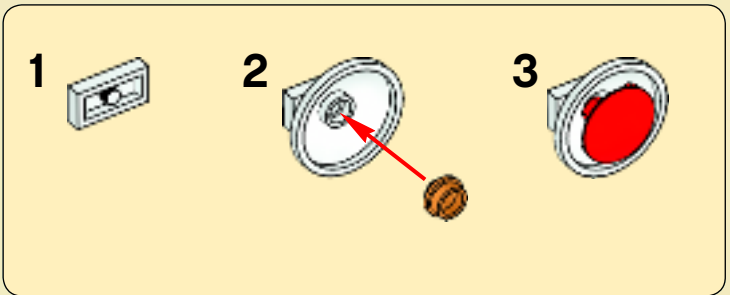

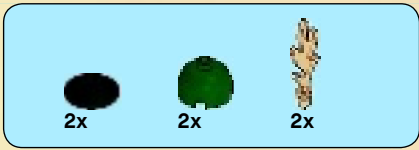

117

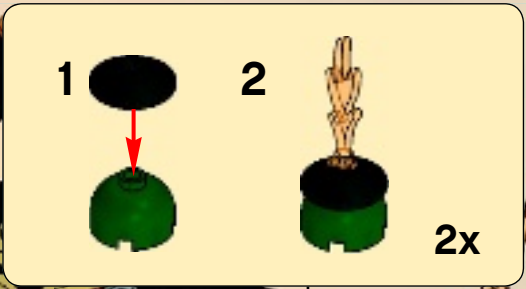

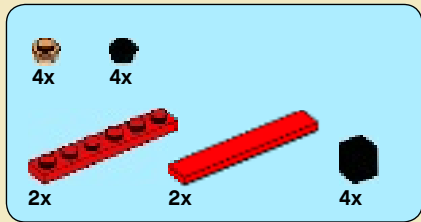

# 118

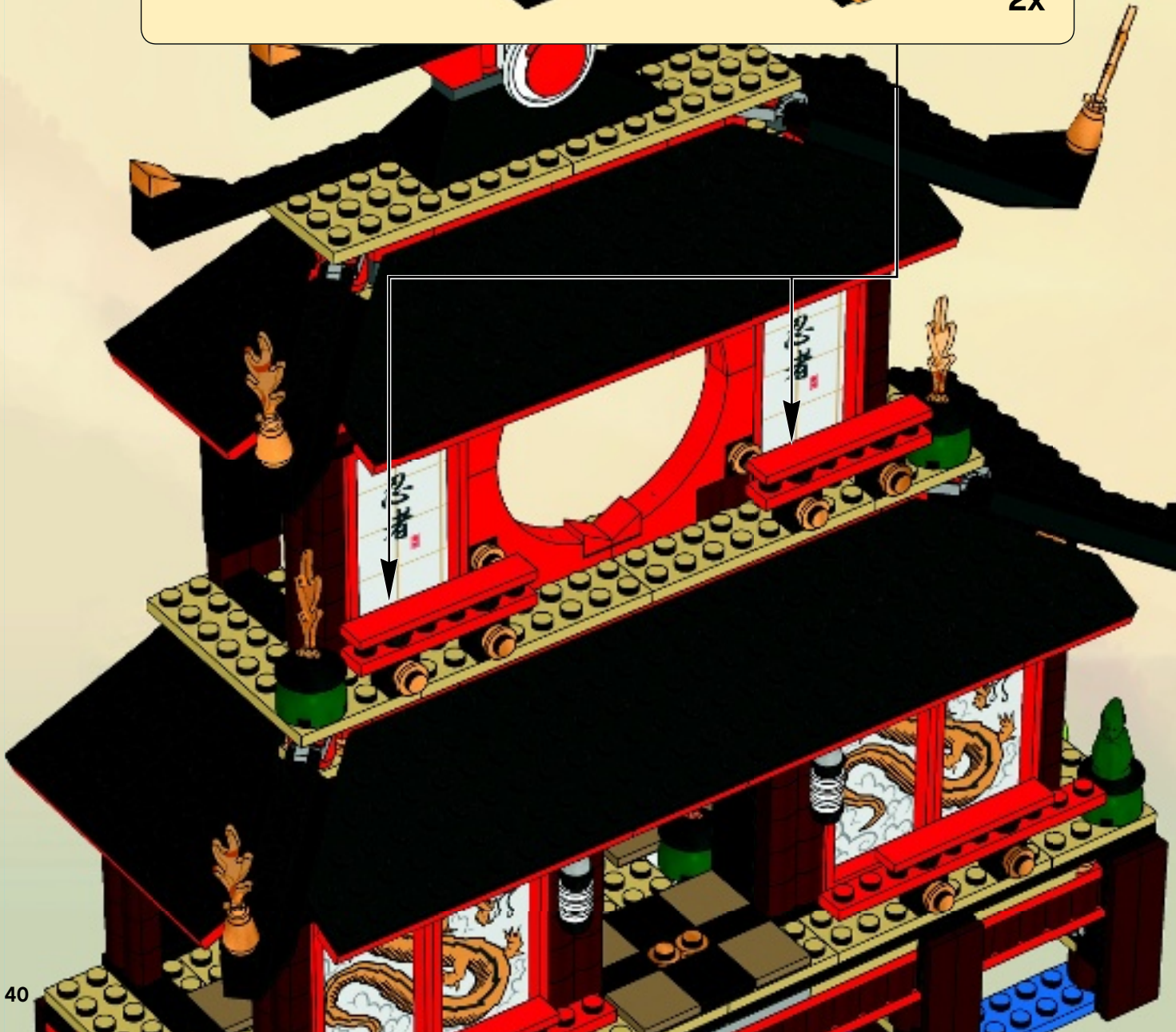
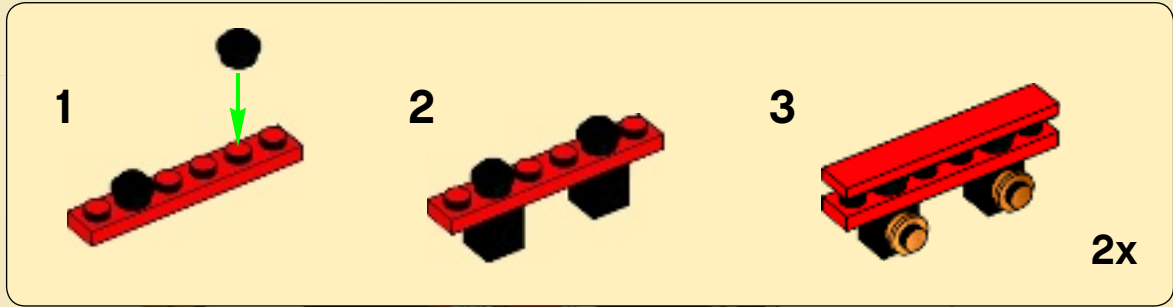



7



1x

1



1x

2

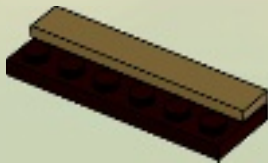

1x

3



1x

4

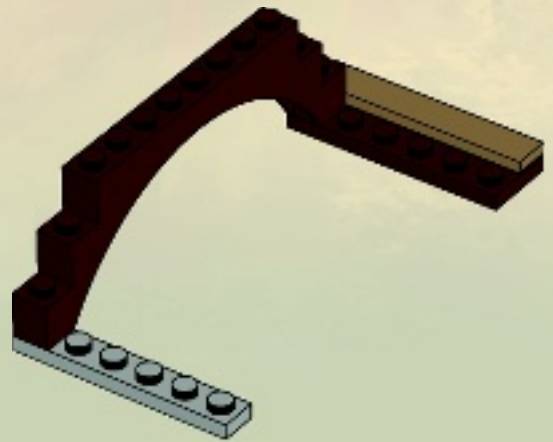

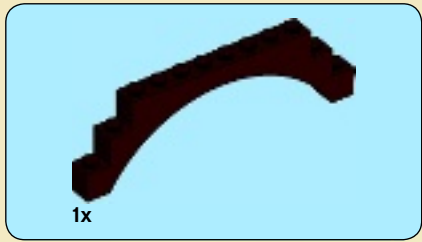

5

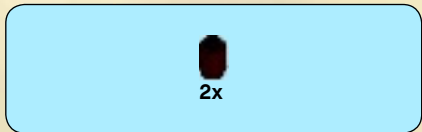
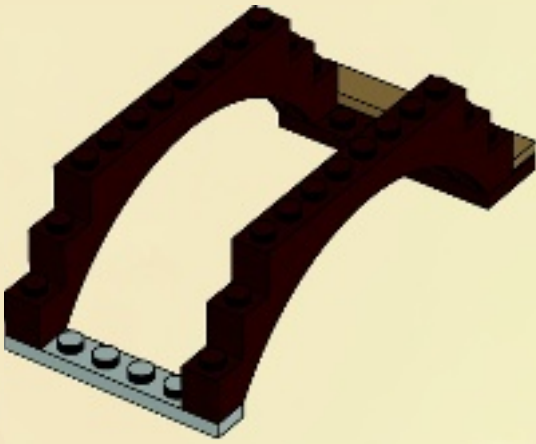

6

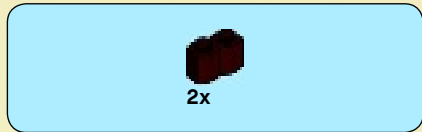
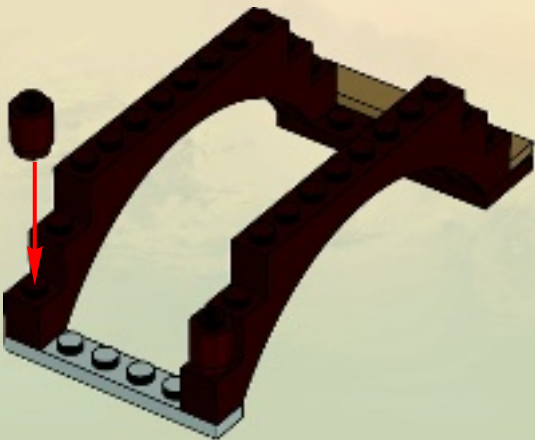

7

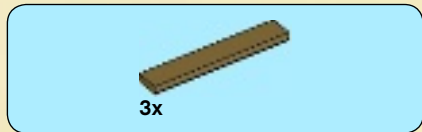
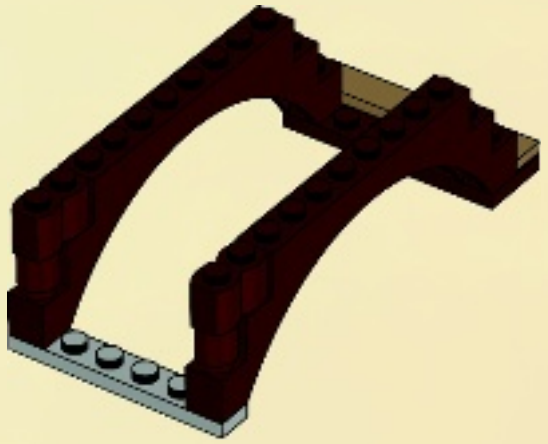

8

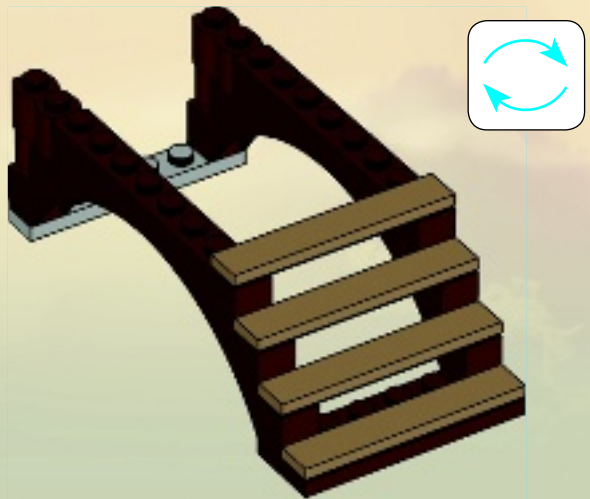

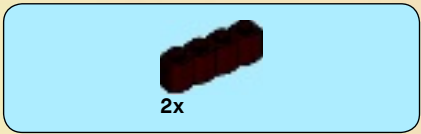

9

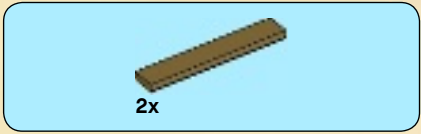
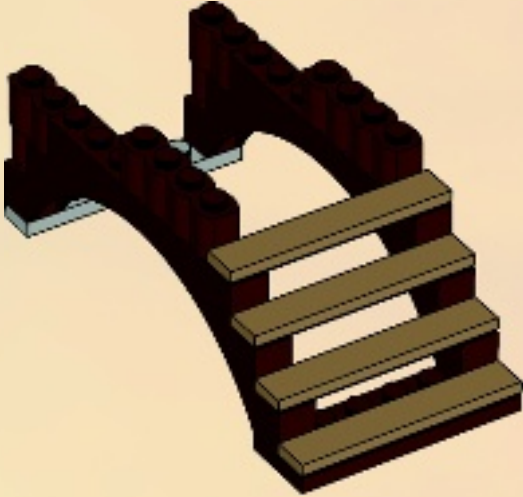

10

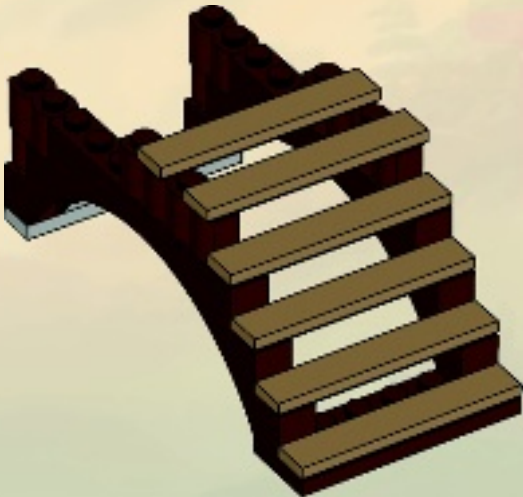

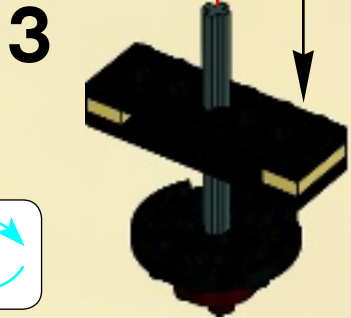
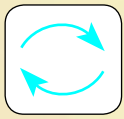
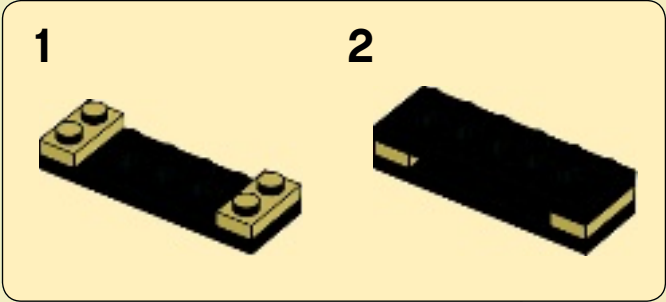
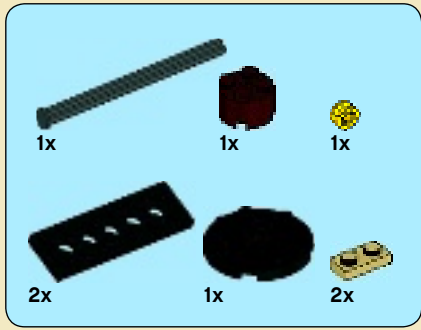

# 11

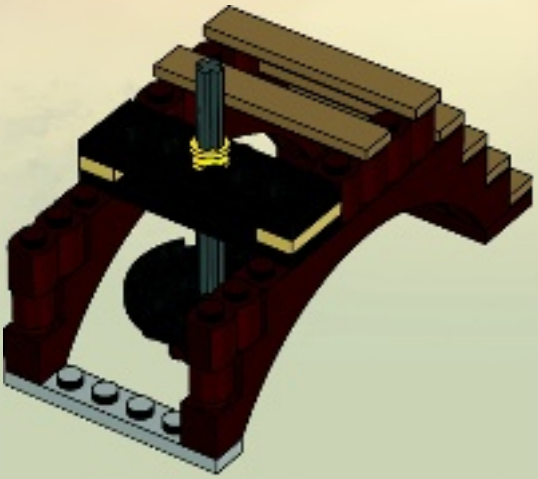



12

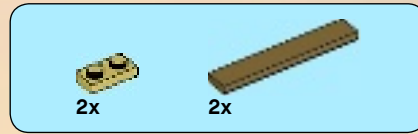
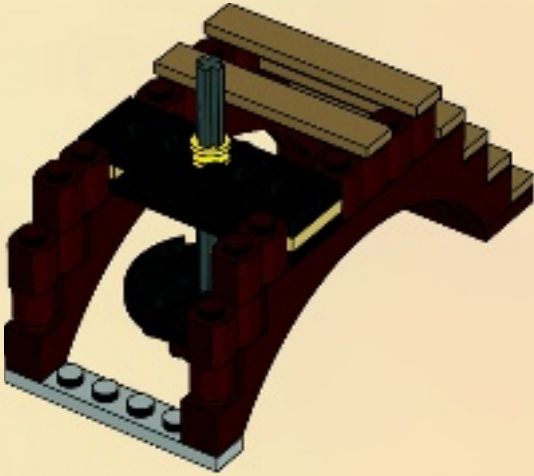

14

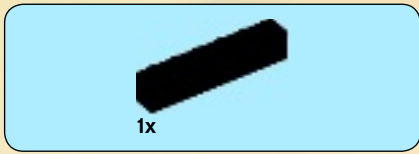
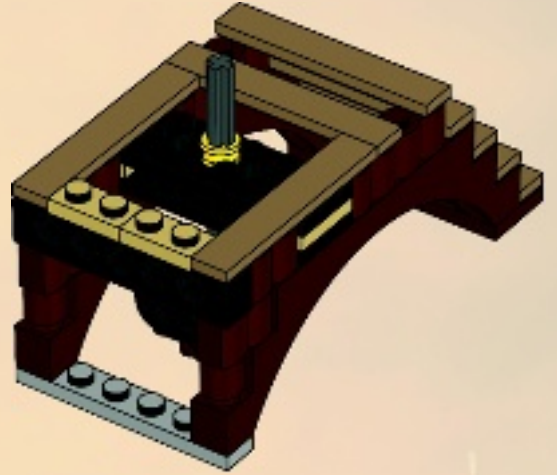

13

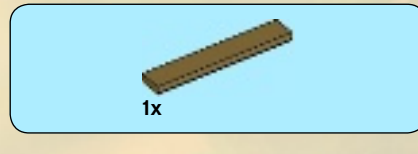
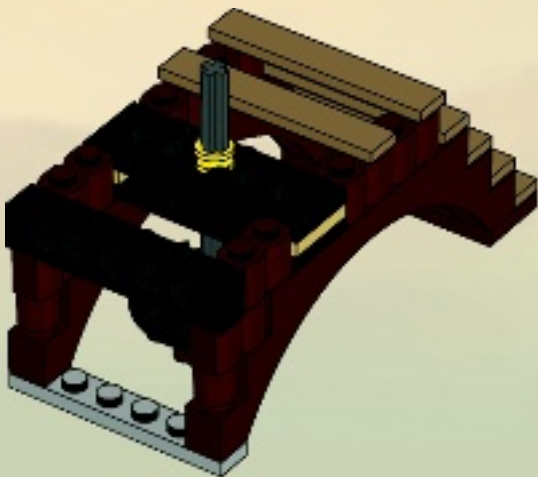

15

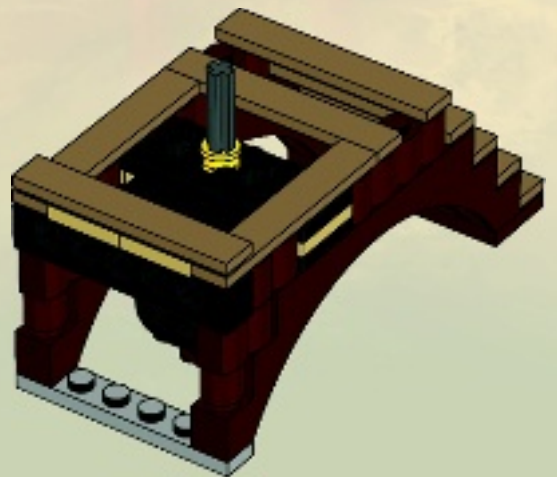



# 16

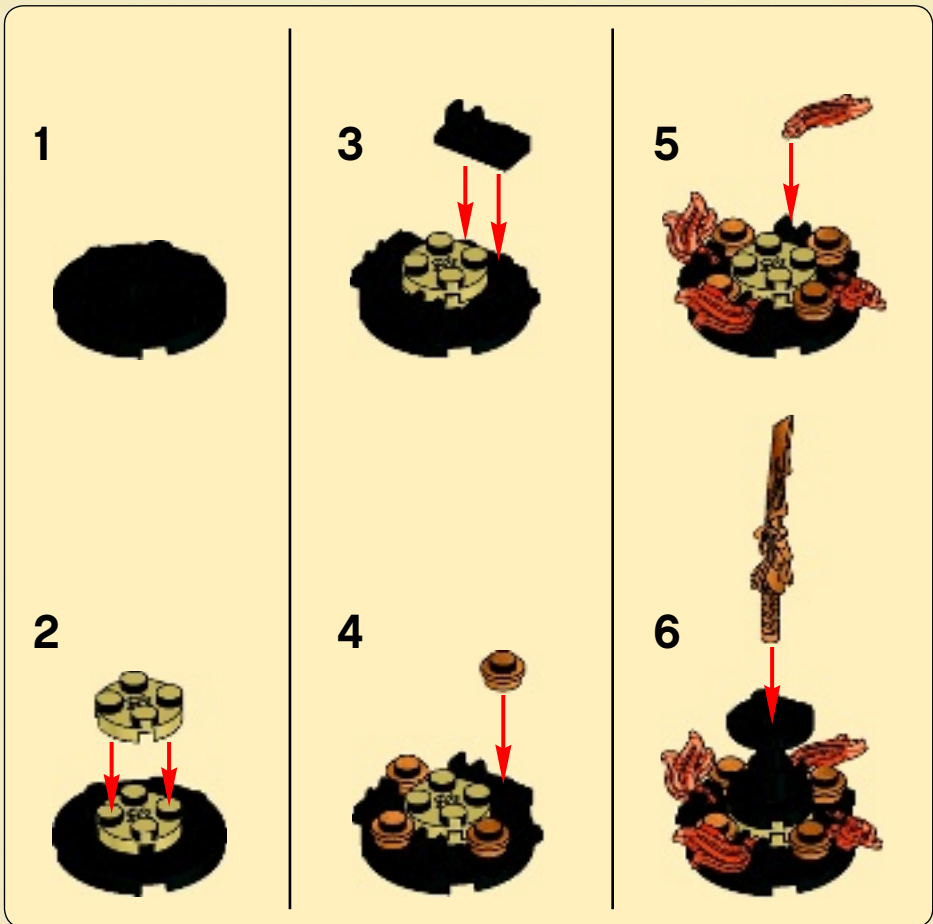



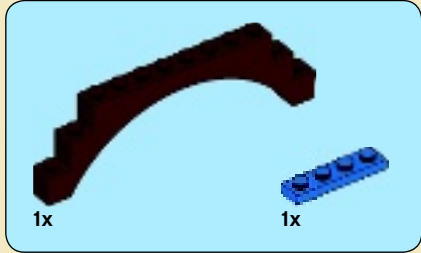

1

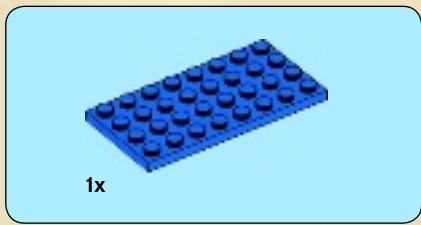

2

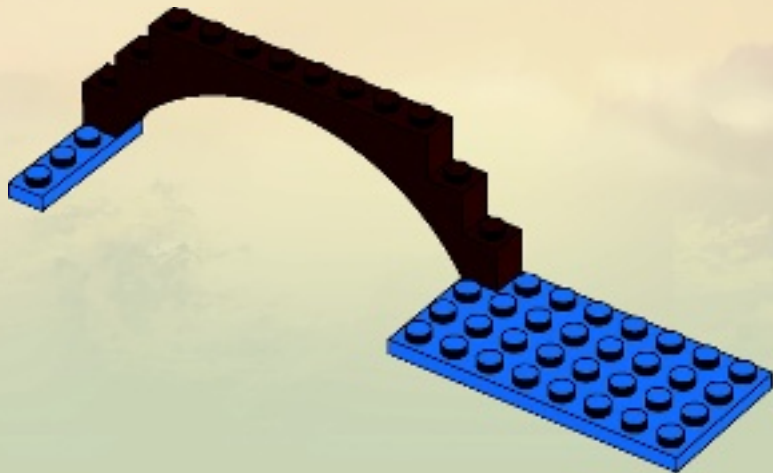







5

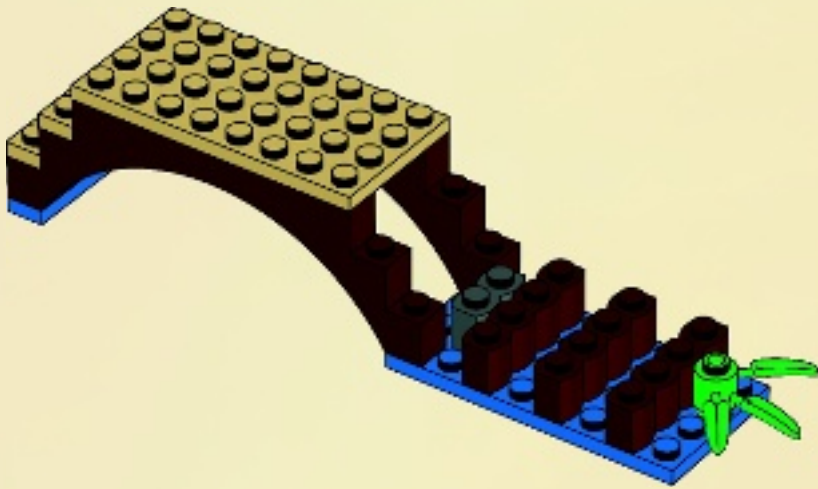

6

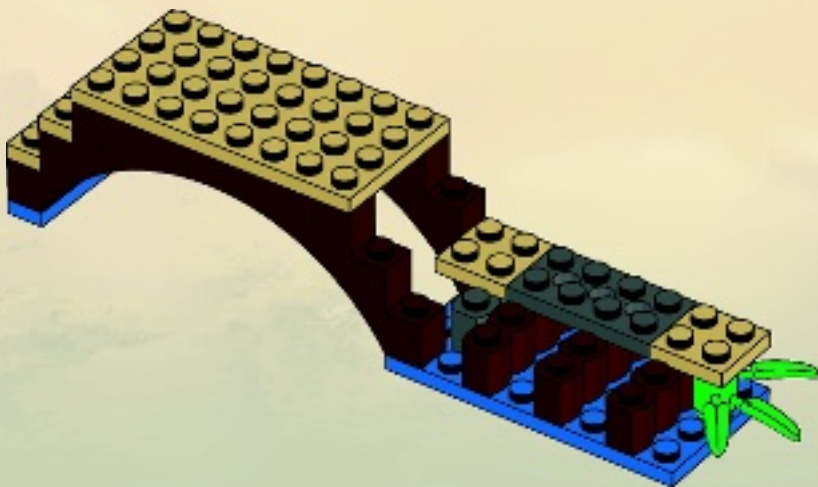

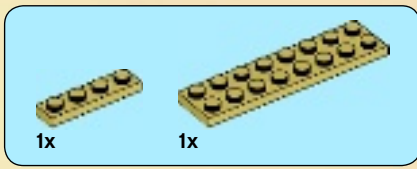

7

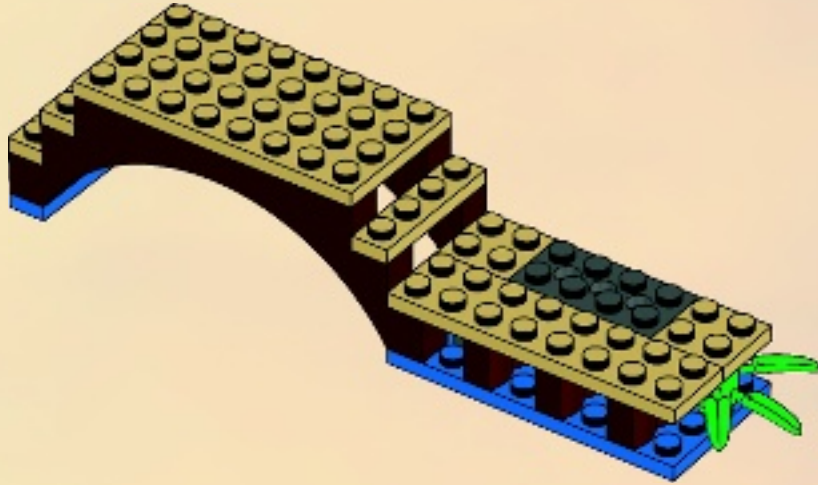

8

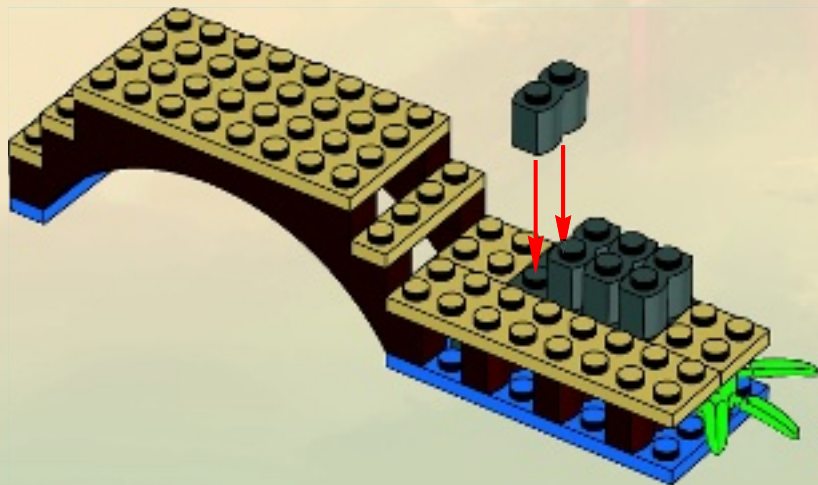

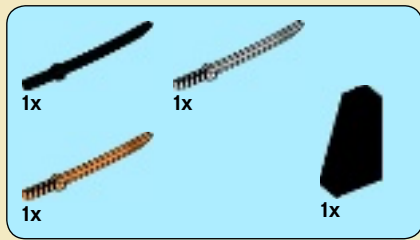

9

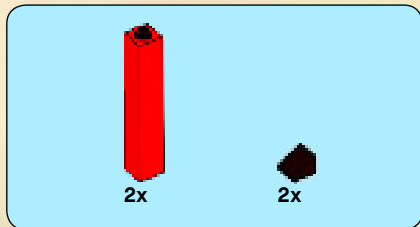
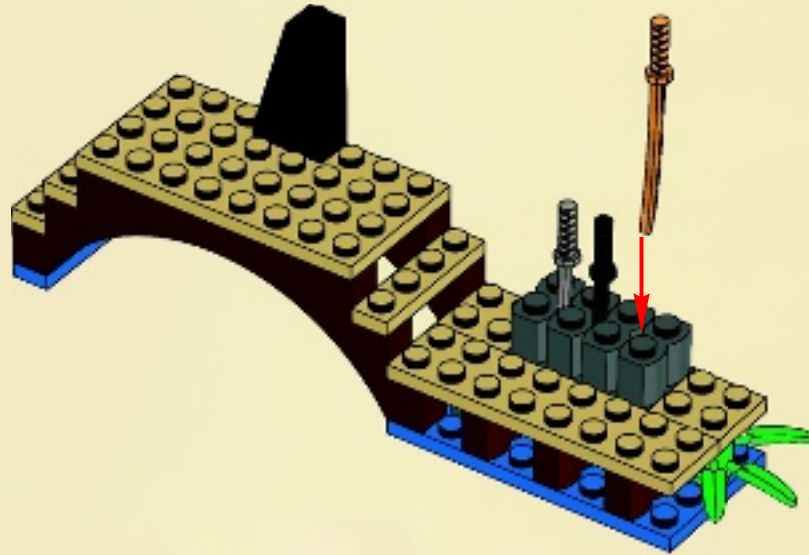

10

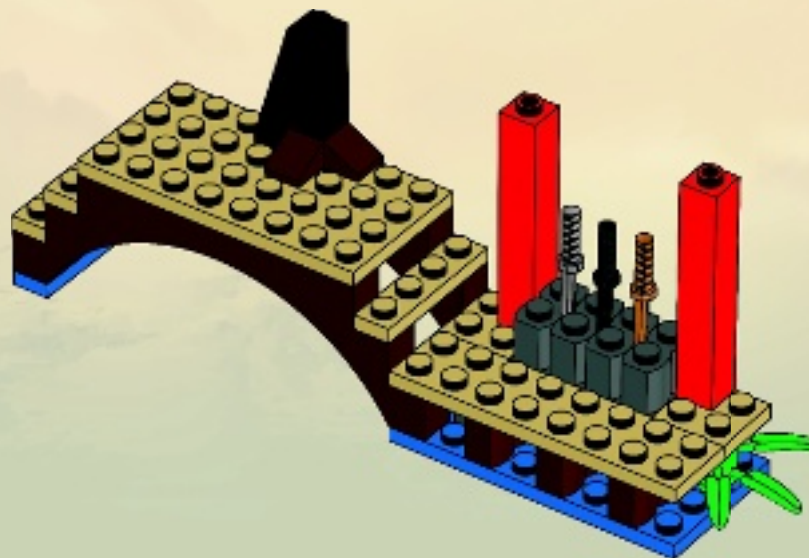

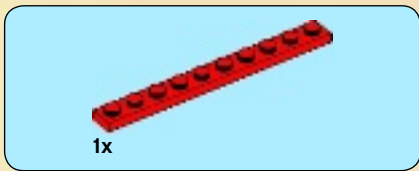

11

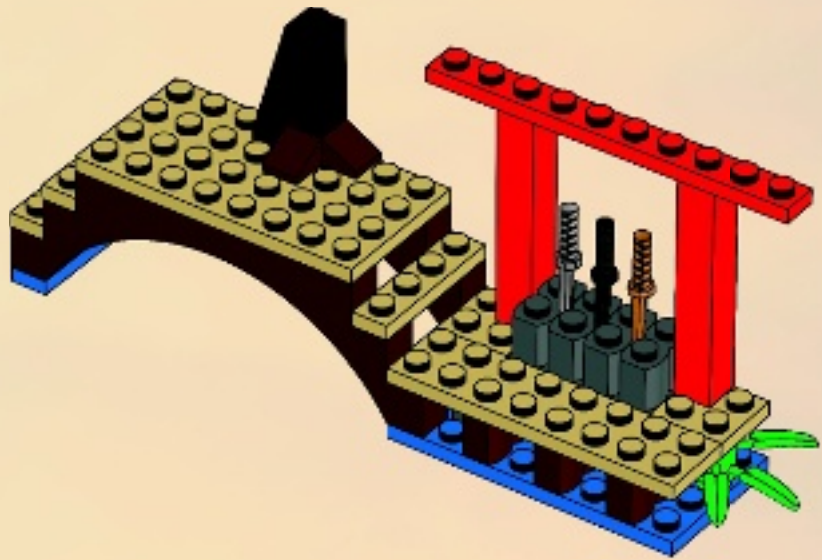

12

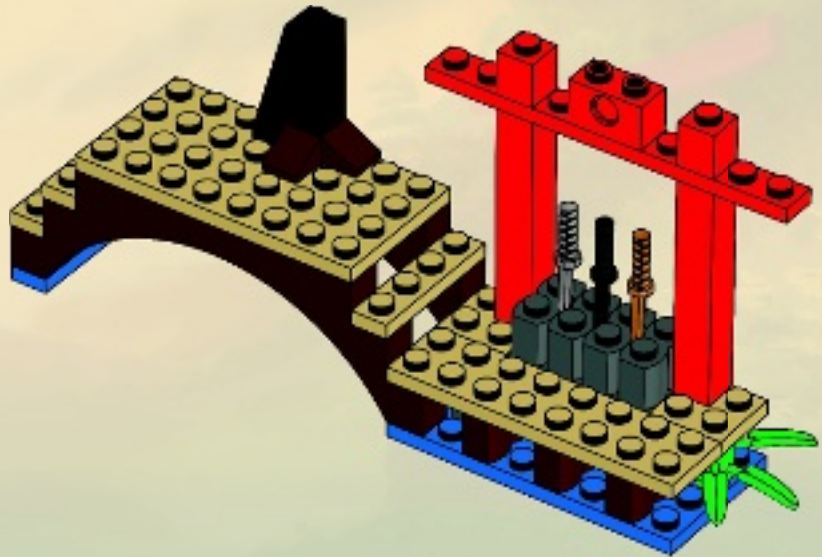



13

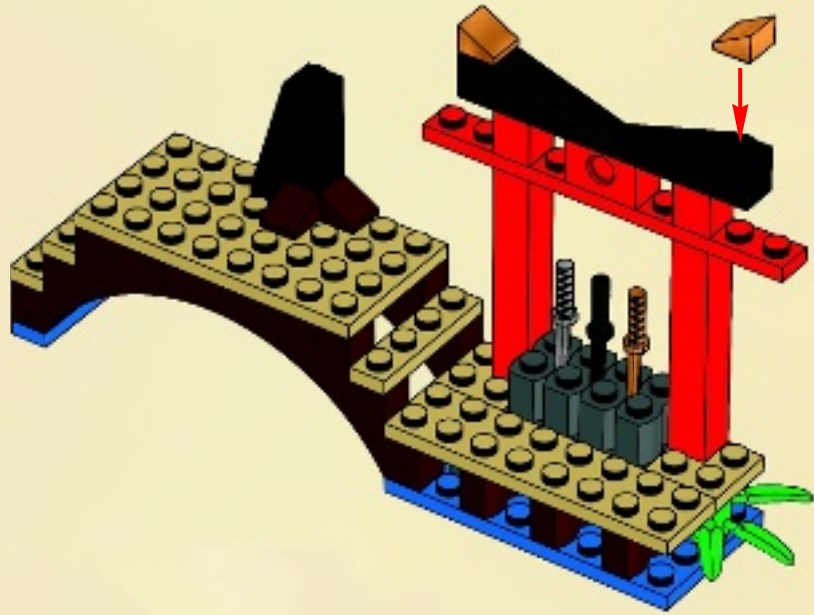

14

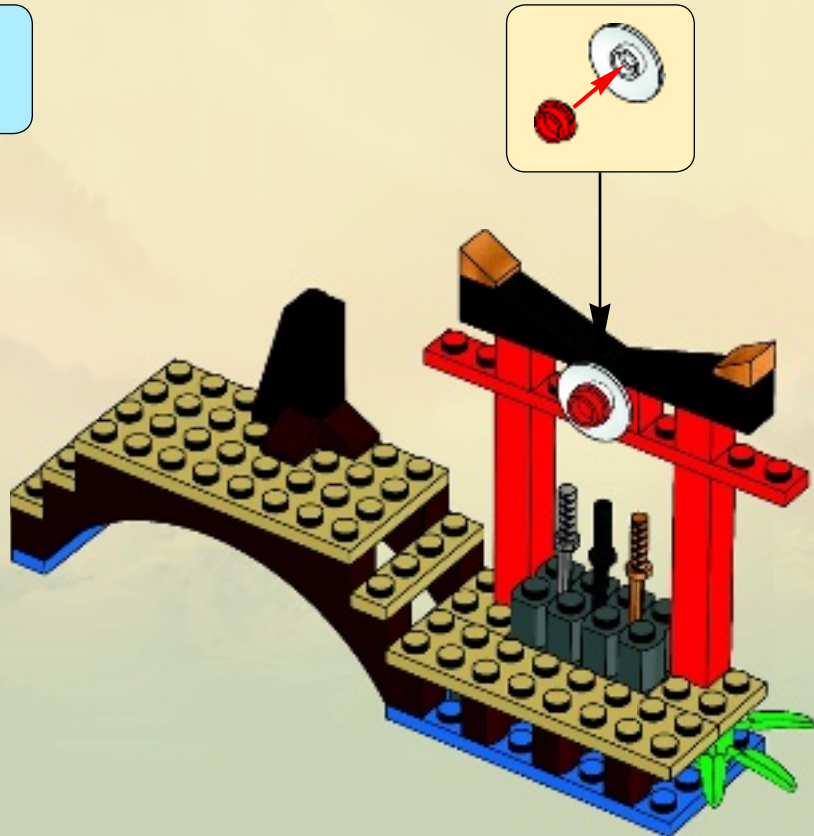

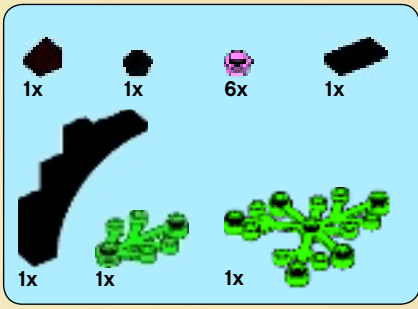

1



2

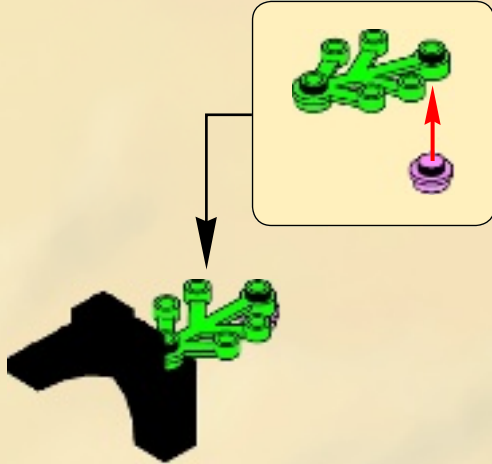

3

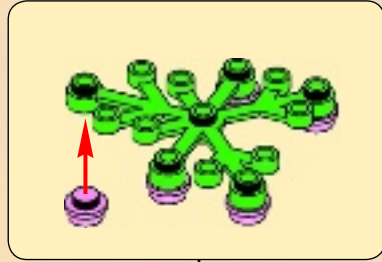

4

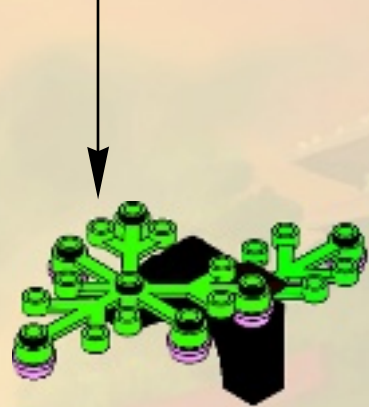

5



15

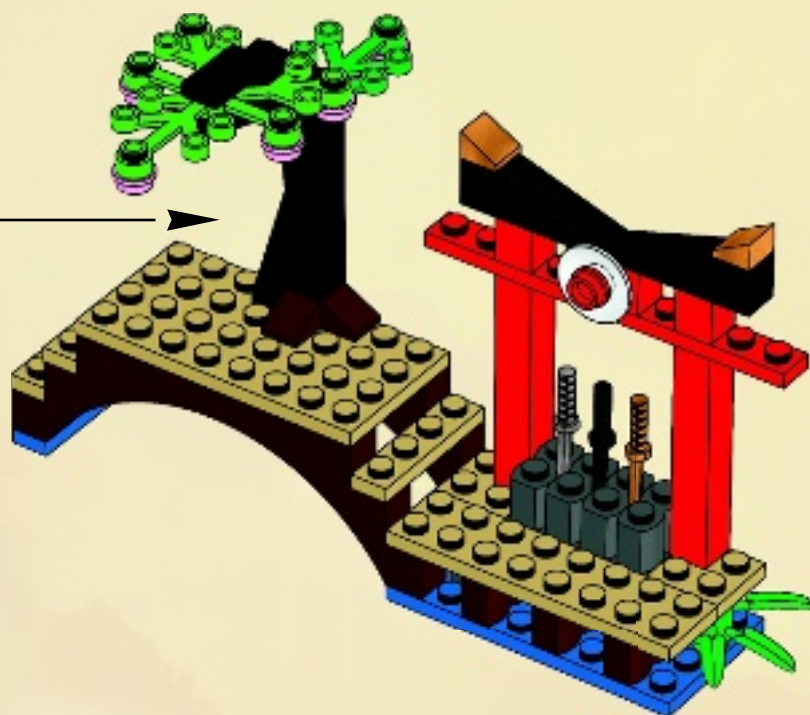



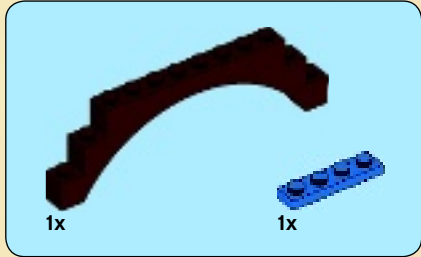
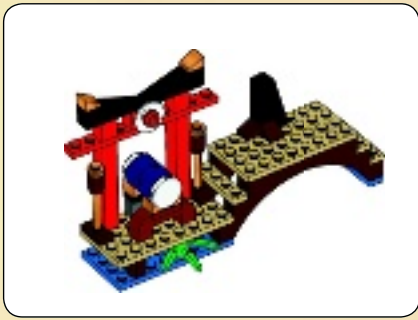

1

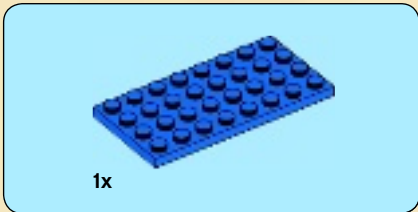

2

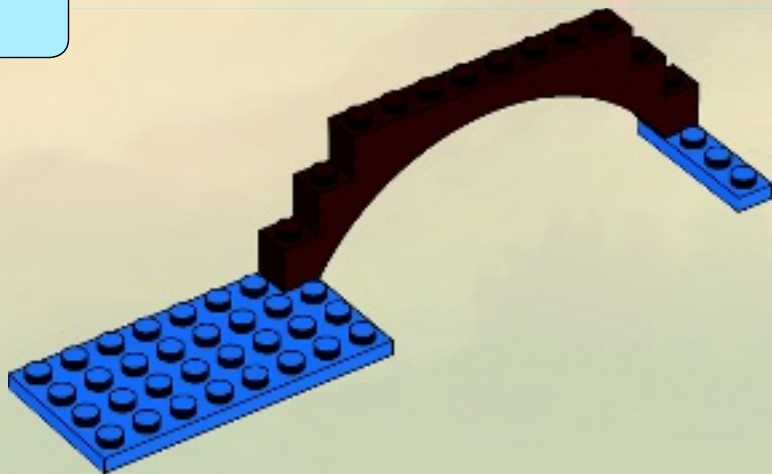

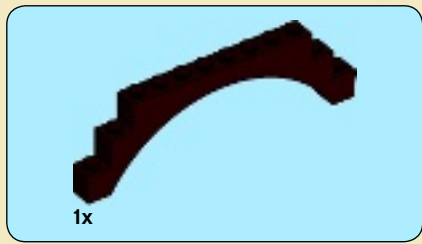

3

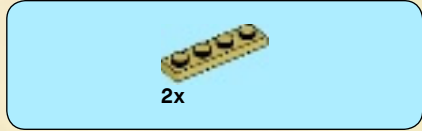
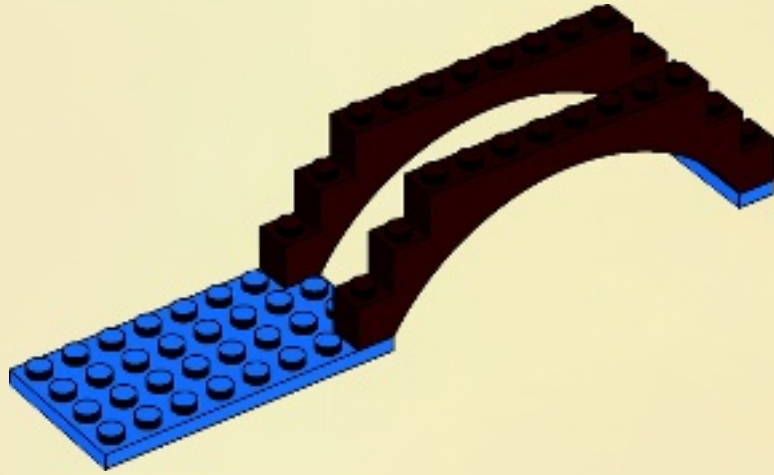

4

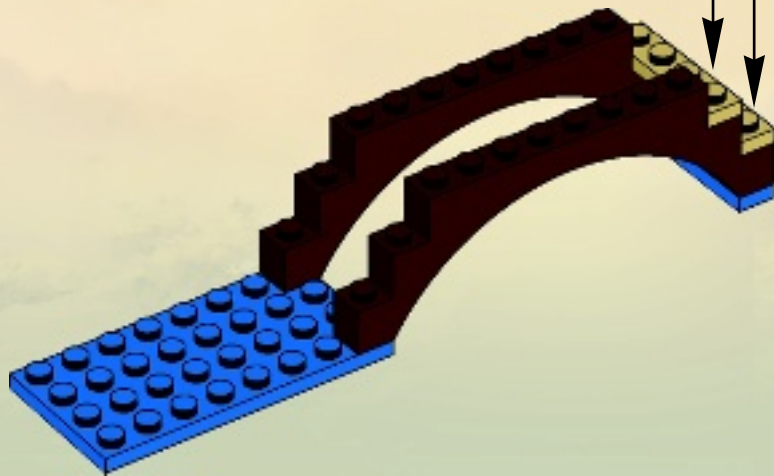
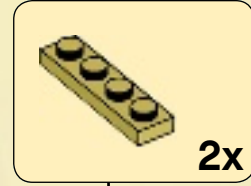

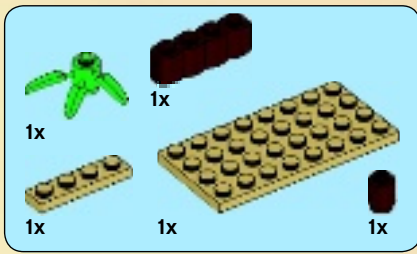

5

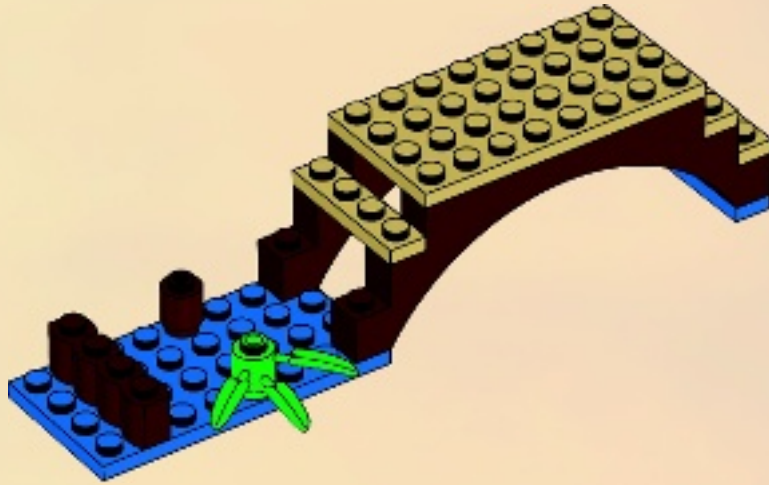

6

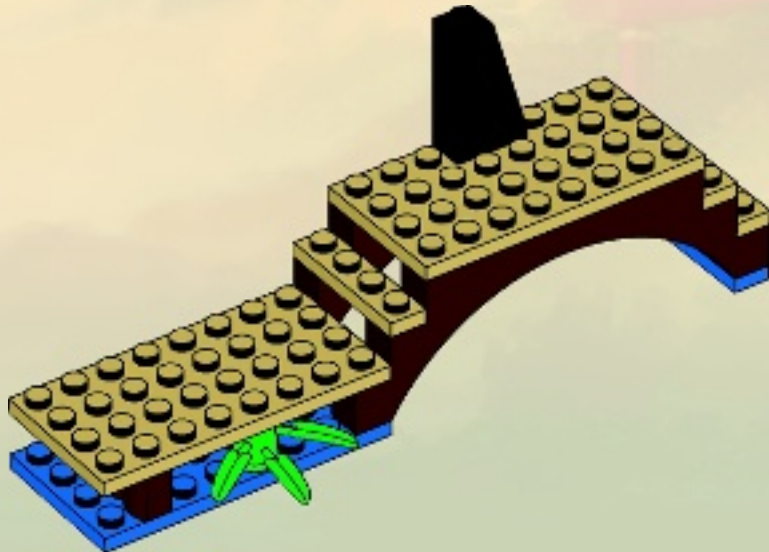



# 7

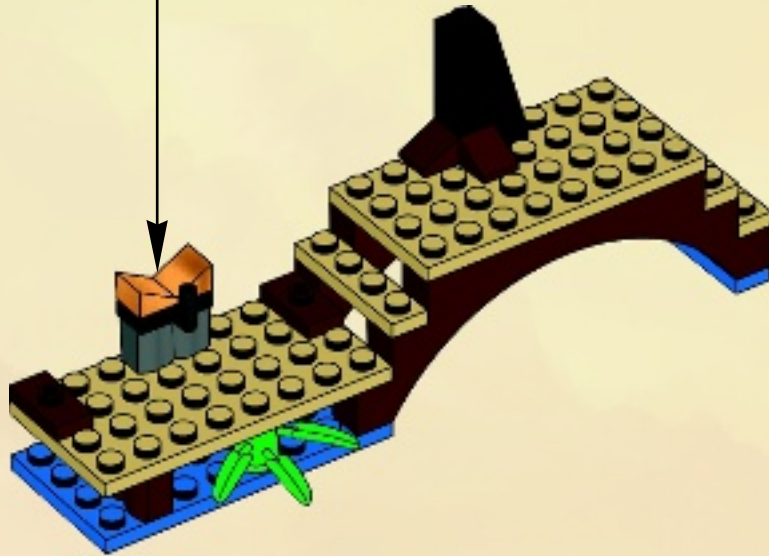

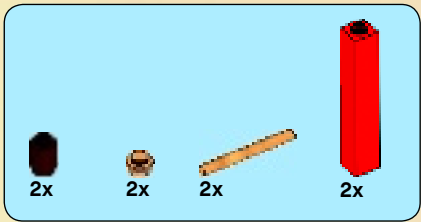

8

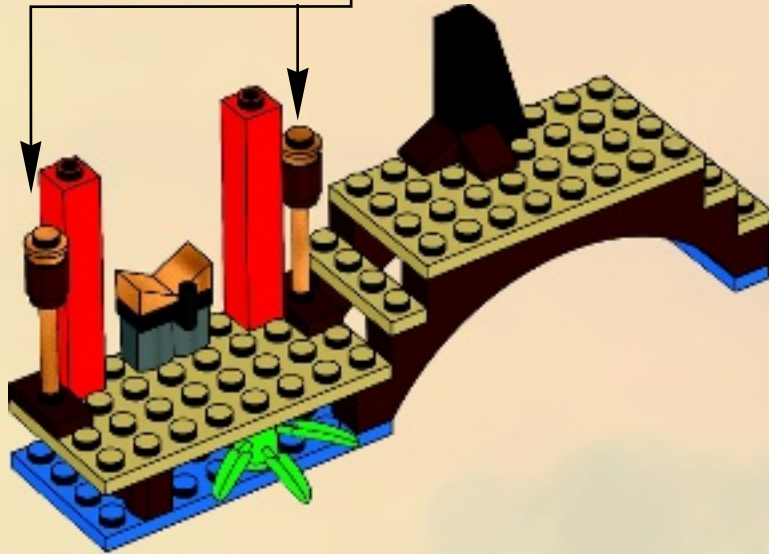
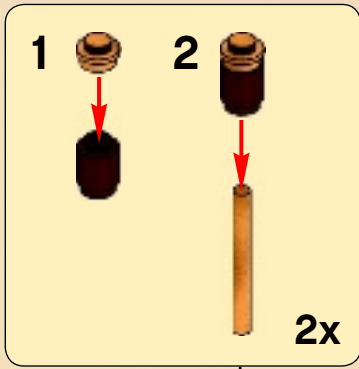

9

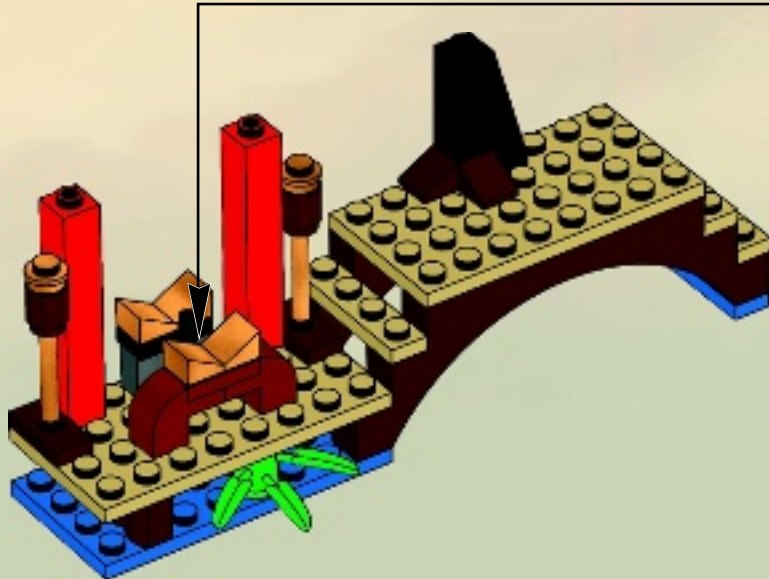



# 10

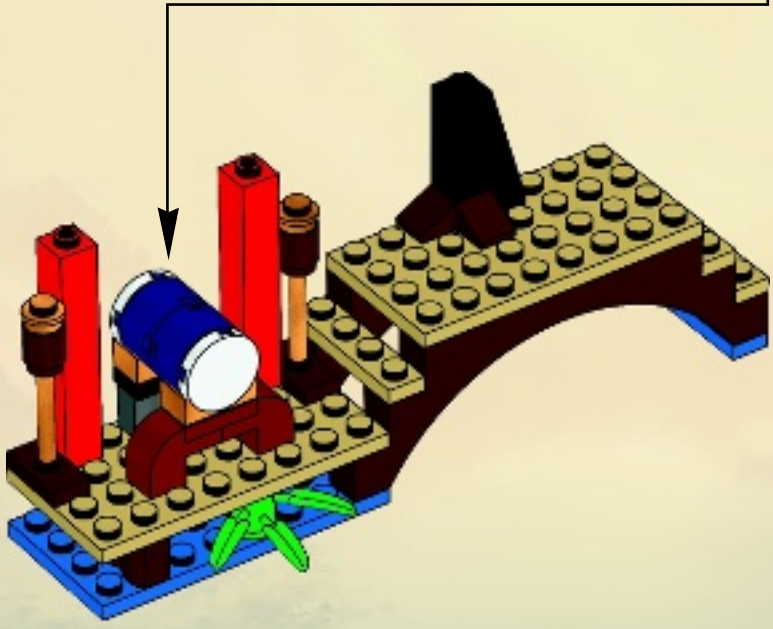
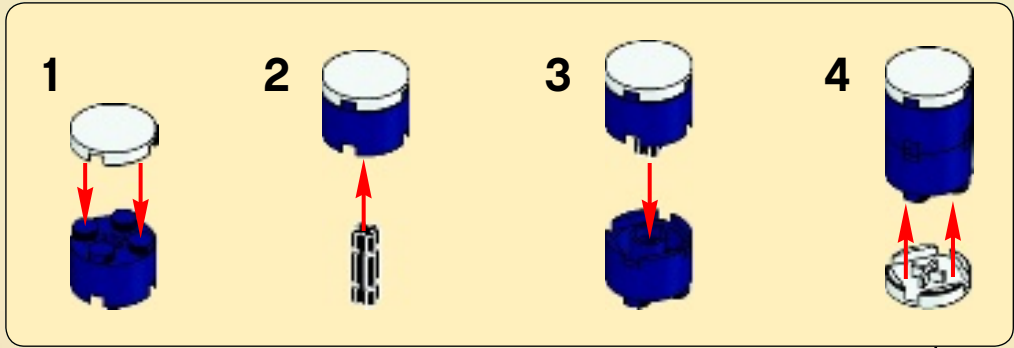

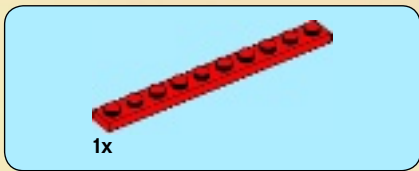

11

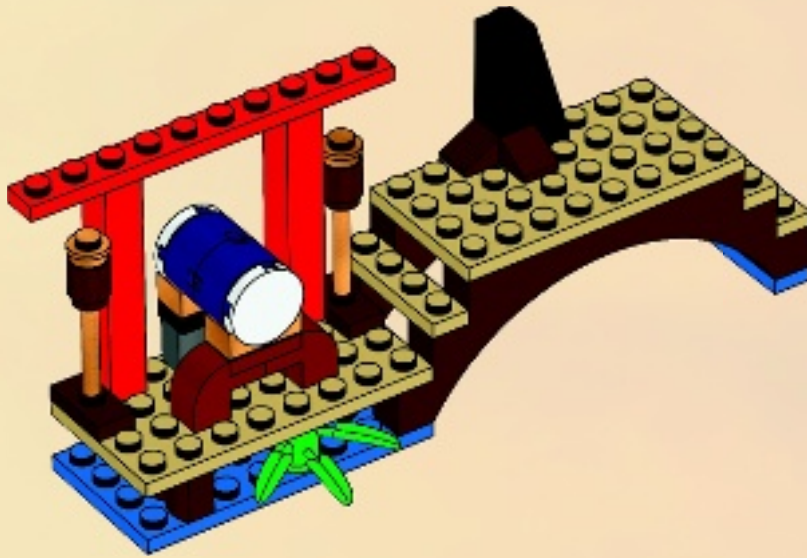

12

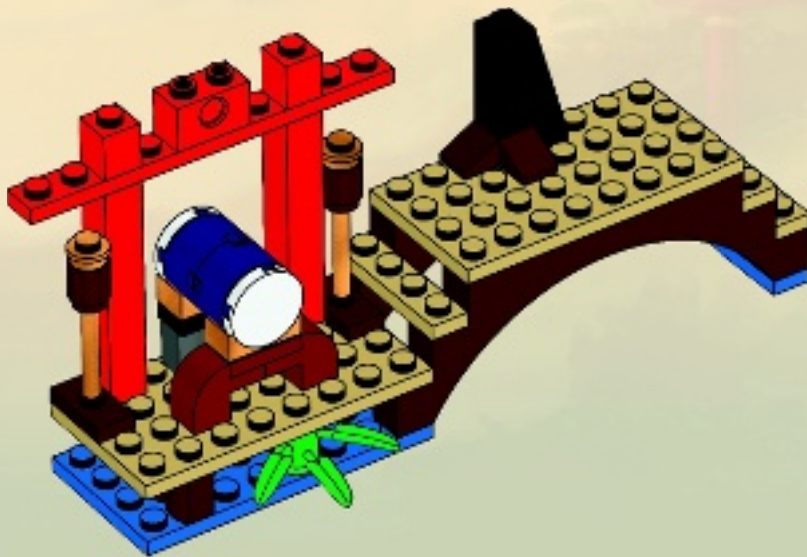



13

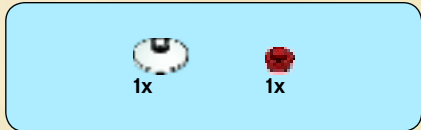
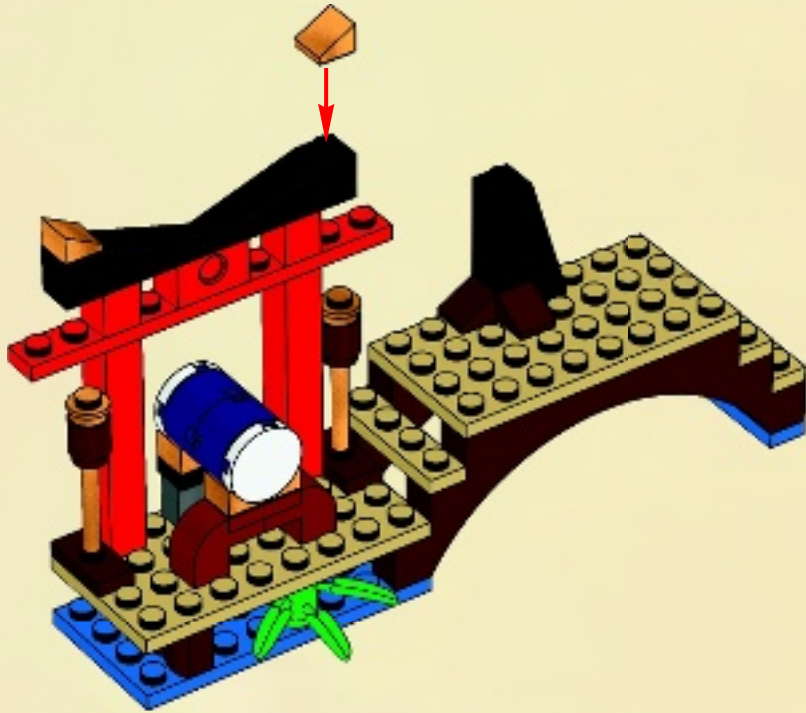

14

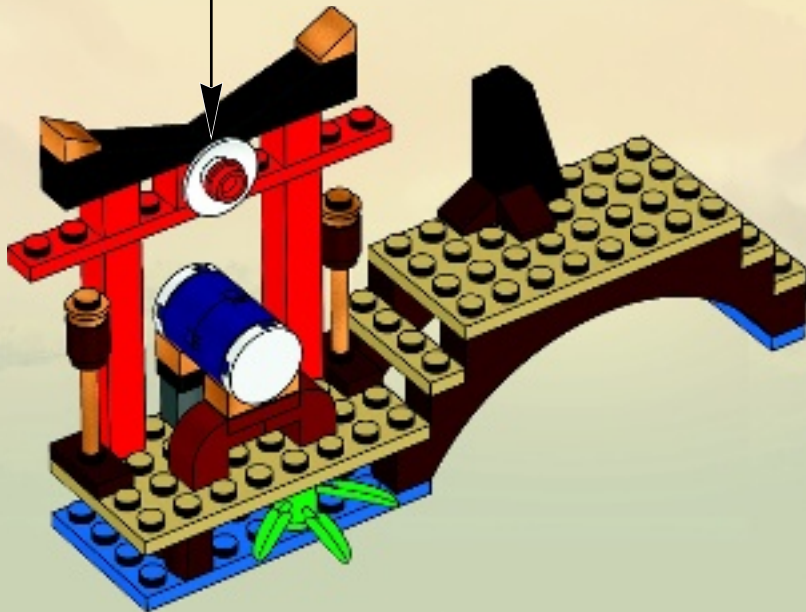
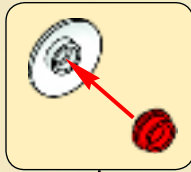



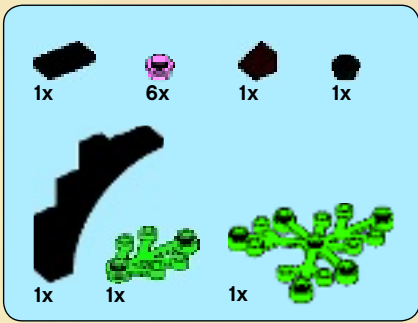

1



2

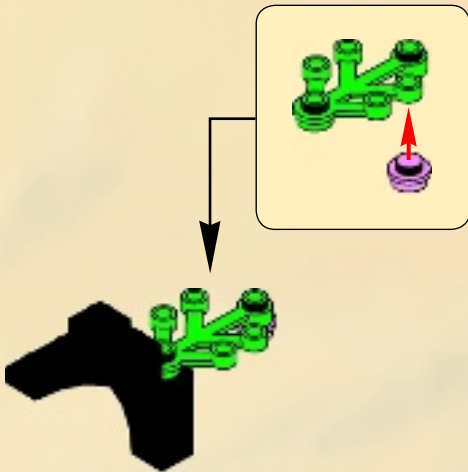

3

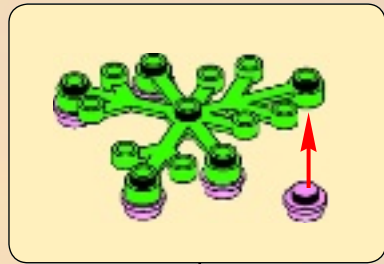

4

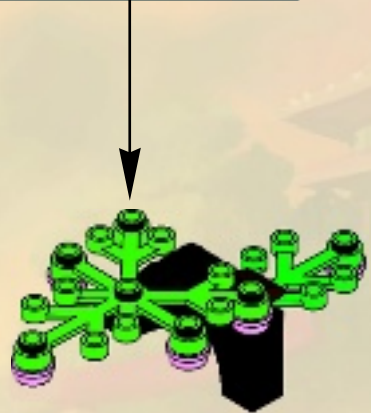

5



15

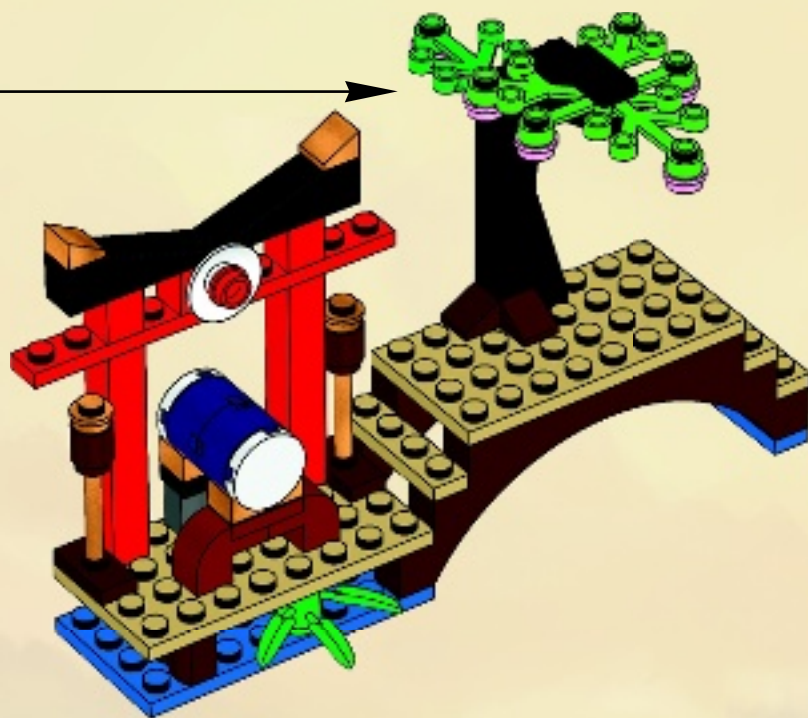



1

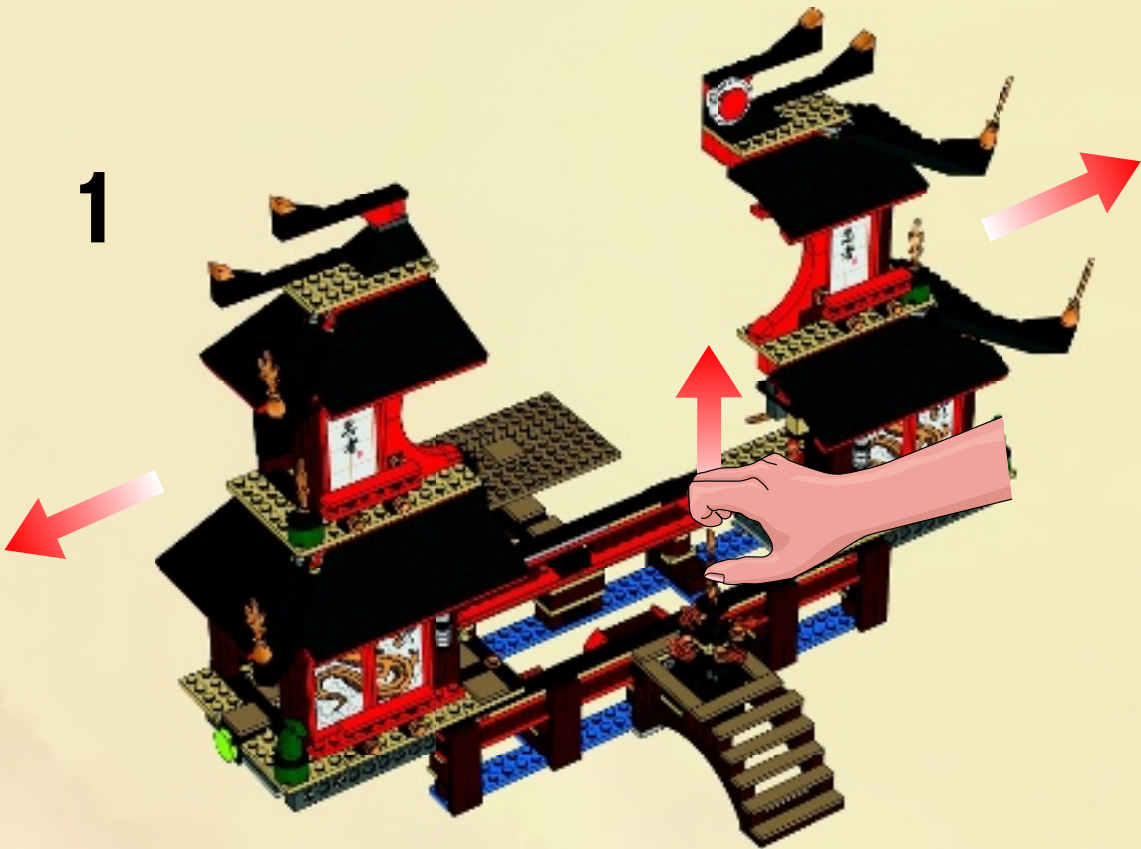

2

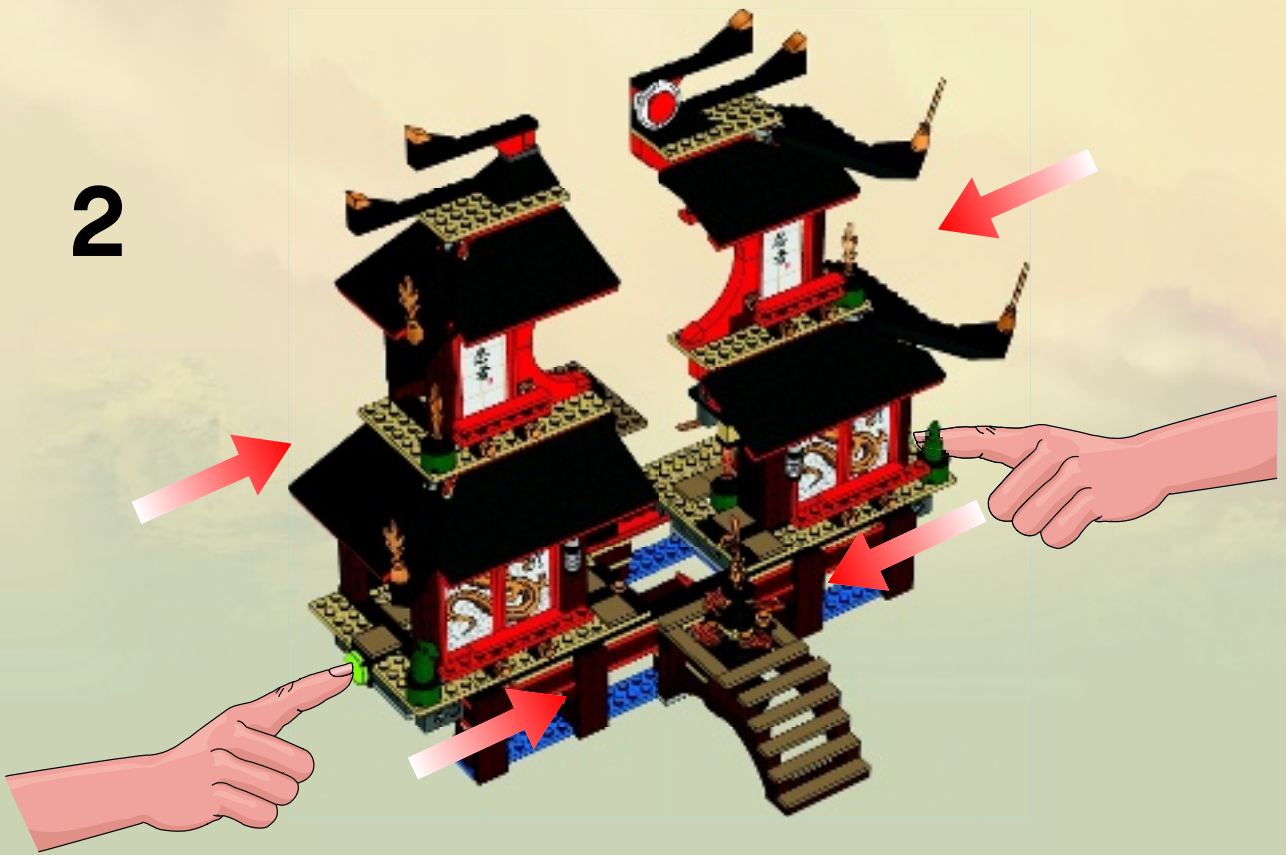



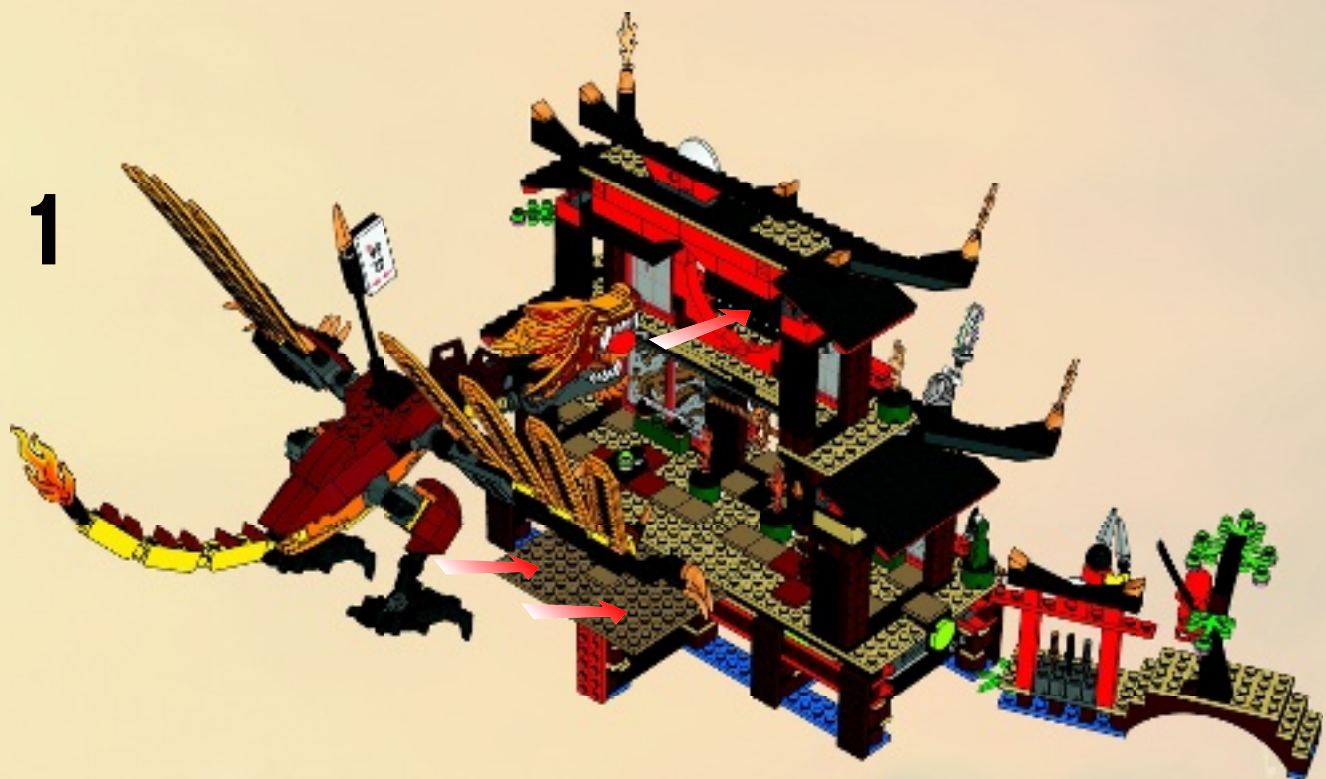







1

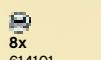
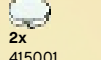

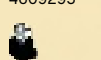

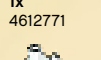
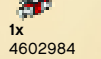

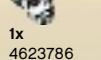

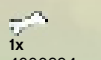
2



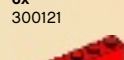
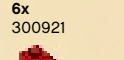
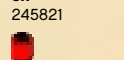
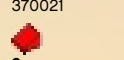



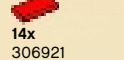

 1x 4612857  
 1x 379401  
 6x 370901  
 8x 614101  
 2x 415001  
 2x 474001  
 1x 4179580  
 1x 4612637  
 6x 4609295  
 4x 4602970  
 1x 4612771  
 1x 4602984  
 1x 4612346  
 1x 4611924  
 1x 4623786  
 1x 4641675  
 1x 4600294  
 1x 4600307  
 1x 4609289

 1x 4544140  
 6x 4162465  
 6x 4112982  
 19x 4113917  
 2x 4114077  
 2x 4114084  
 12x 4113233  
 6x 4114309  
 6x 4243824  
 1x 4113988  
 17x 4509897  
 2x 4140593  
 15x 4140562  
 1x 4609291  
 4x 4514554  
 4x 300521  
 4x 4212410  
 4x 362221

 6x 300121  
 6x 300921  
 3x 245821  
 7x 306221  
 1x 654121  
 2x 370021  
 2x 4504379  
 2x 366521  
 2x 4603263  
 6x 4500462  
 2x 4629998  
 2x 4629997  
 14x 306921  
 2x 371021  
 4x 366621  
 4x 4113858  
 6x 346021  
 10x 447721

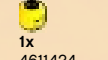
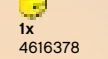
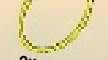
 12x 4544531  
 2x 614121  
 1x 4278275  
 6x 4550015  
 4x 4190219  
 4x 486521  
 1x 4616366  
 1x 4619618  
 1x 4641677  
 12x 613421  
 1x 4622390  
 1x 302223  
 2x 371023  
 10x 303423  
 2x 303523  
 6x 4206482  
 3x 4218728  
 3x 370024

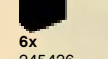
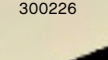
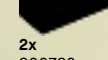
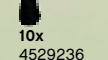
 1x 4277159  
 4x 302224  
 2x 362324  
 3x 302024  
 12x 4205196  
 1x 4611424  
 1x 4611429  
 1x 4616378  
 1x 4611432  
 2x 4544151  
 1x 4239601  
 6x 245426  
 3x 300326  
 2x 300226  
 2x 300726  
 16x 4558954  
 10x 4529236  
 2x 3200026  
 1x 370126

 1x 389426  
 2x 370226  
 2x 4144025  
 2x 389526  
 10x 428626  
 4x 4515362  
 2x 367526  
 8x 4581280  
 6x 306926  
 6x 302326  
 4x 362326  
 6x 302126  
 12x 346026  
 8x 416226  
 6x 303226  
 2x 383226



2x 303626  
 2x 4514845  
 4x 303026  
 4x 255526  
 1x 394026  
 4x 4598528  
 1x 4569733  
 21x 4277932  
 2x 4535739  
 1x 4613759  
 2x 4604304  
 2x 3200126  
 4x 4192456  
 19x 614126  
 6x 474026  
 6x 4515350  
 2x 4227684

10x 4106977  
 1x 4631558  
 1x 4616334  
 1x 4630138  
 6x 4650022  
 1x 4616311  
 1x 4526756  
 1x 4624209  
 2x 4598897  
 2x 4114206  
 2x 4143372  
 1x 4159335  
 4x 4213374  
 1x 4209159  
 1x 4636072  
 1x 4598407  
 2x 4584550  
 3x 4184169

4x 4107082  
 1x 4109810  
 11x 4121715  
 1x 4526982  
 4x 4119589  
 2x 242328  
 2x 4114348  
 2x 4129872  
 2x 4639781  
 2x 4639782  
 2x 4639783  
 1x 4548009  
 2x 612647  
 4x 4540865  
 2x 4613934  
 2x 4177932

4x 4180512  
 4x 4180540  
 2x 4587102  
 2x 4164037  
 1x 4183133  
 2x 4541957  
 1x 4514700  
 23x 4507045  
 9x 4507047  
 2x 4251796  
 2x 4566927  
 2x 4505985  
 2x 4245571  
 6x 4265392  
 2x 4619469  
 1x 4541369  
 2x 4539059  
 20x 4531415  
 4x 4541526

2x 4541380  
 2x 4539081  
 1x 4541523  
 1x 4541524  
 2x 4539082  
 4x 4541546  
 2x 4611666  
 2x 4539097  
 14x 4539105  
 5x 4539061  
 6x 4261397  
 2x 4525868  
 2x 4525869  
 8x 4629838  
 1x 4630187  
 6x 4211201  
 70x 4211180

19x 4211181  
 5x 4211183  
 15x 4211166  
 2x 4267994  
 6x 4504376  
 6x 4584719  
 3x 4211194  
 3x 4211186  
 8x 4211204  
 7x 4211247  
 2x 4219726  
 3x 4211219  
 1x 4538724  
 3x 4252456  
 2x 4211718  
 2x 4211466  
 7x 4211438  
 1x 4211369  
 4x 4211803



2x  
4211503

1x  
4211628

1x  
4539481

2x  
4616840

9x  
4211483

4x  
4211375

2x  
4211815

8x  
4225033

2x  
4211103

6x  
4211095

4x  
4225973

1x  
4497253

4x  
4225975

4x  
4209726

6x  
4211137

1x  
4294180

4x  
4211063

1x  
4227398

2x  
4212075

1x  
4609368

2x  
4289542

12x  
4211066

1x  
4516456

2x  
4210665

2x  
4508553

1x  
4499858

12x  
4517996

6x  
4529247

12x  
4587002

65x  
4523159

1x  
4579099

3x  
4600267

1x  
4600270

10x  
4618195

1x  
4626501

3x  
4640843

2x  
4600519

3x  
4614404

1x  
4614710

7x  
4611904

1x  
4600501

1x  
4273965

2x  
4518562

2x  
4518606

2x  
4566688

1x  
4616331

3x  
4612900

1x  
4611883

1x  
4631534

1x  
4631535

1x  
4631541

Customer Service  
Kundenservice  
Service Consommateurs  
Servicio Al Consumidor

[www.lego.com/service](http://www.lego.com/service) or dial



: 00800 5346 5555

: 1-800-422-5346



# NINJAGO

Masters of Spinjitzu



2257



2254



2174



2175



2255



2256



# NINJAGO

Masters of Spinjitzu



2170  
2507  
2509



2508  
2507



2170



2170  
2507  
2508  
2509



2171



2171



2171  
2507  
2508



2507



2172



2172  
2507



2173



2173  
2174



2173  
2256  
2508



2174



2174  
2175



2175



2175



2255



2255



2255  
2507  
2508



2256



2256



2506



2506  
2507



2506  
2507



2506  
2507



2507  
2254



2507



2508



2508



2509



2509



2254



2254



# NINJAGO

Masters of Spinjitzu



JAY  
2257 - 2506



KAI DX  
2507 - 2508 - 2254



ZANE  
2506 - 2507



COLE DX  
2170 - 2509



NYA  
2172 - 2507



SENSEI WU  
2255 - 2507



GARMADON  
2256 - 2506 - 2507



SAMUKAI  
2507



NUCKAL  
2173



FRAKJAW  
2257



KRUNCHA  
2174 - 2507



WYPLASH  
2175 - 2506 - 2509



**NINJAGO**  
Masters of Spinjitzu





# NINJAGO

Masters of Spinjitzu



**NINJAGO.COM**



# NINJAGO

Masters of Spinjitzu



NINJAGO.COM



# NINJAGO

THE VIDEO GAME  
LE JEU VIDÉO  
EL VIDEO JUEGO



**OUT NOW!**  
**MAINTENANT DISPONIBLE !**  
**¡DISPONIBLE AHORA!**

LEGO Bricx, Ninjabot software © 2011 TT Games Publishing Ltd. Produced by TT Games under license from the LEGO Group. LEGO, the LEGO logo, the Brick and the Knob configurations and the Minifigure are trademarks of the LEGO Group. © 2011 The LEGO Group. Hellbent Games and the Hellbent logo are trademarks of Hellbent Games Inc. Nintendo DS is a trademark of Nintendo. © 2004 Nintendo. All other trademarks and copyrights are the property of their respective owners. All rights reserved.

LEGO Bricx, Le logiciel Ninjabot © 2011 TT Games Publishing Ltd. Produit par TT Games sous licence de LEGO Group. LEGO, le logo LEGO, le Bricx et les configurations du Bricx et la Minifigure sont des marques de commerce de LEGO Group. © 2011 The LEGO Group. Hellbent Games et le logo Hellbent sont des marques de commerce de Hellbent Games Inc. Nintendo DS est une marque de commerce de Nintendo. © 2004 Nintendo. Toutes les autres marques de commerce et droits d'auteur sont la propriété de leurs propriétaires respectifs. Tous droits réservés.

LEGO Bricx, Software Ninjabot © 2011 TT Games Publishing Ltd. Produced by TT Games under license from the LEGO Group. LEGO, the logo LEGO, the Brick and the Knob configurations and the Minifigure are trademarks of the LEGO Group. © 2011 The LEGO Group. Hellbent Games and the Hellbent logo are trademarks of Hellbent Games Inc. Nintendo DS is a trademark of Nintendo. © 2004 Nintendo. Todos los otros marcas y derechos son propiedad de sus dueños respectivos. Todos los derechos reservados.



[www.pegi.info](http://www.pegi.info)

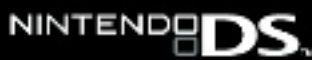



# NINJAGO

THE BOARD GAME  
LE JEU DE SOCIÉTÉ



3856



2-4



8+



15 - 25



[www.LEGO.com/LEGOGames](http://www.LEGO.com/LEGOGames)



www.LEGOclub.com

FREE! GRATIS! GRATUIT!



LEGO® Club Magazine



LEGO® Club Email

SIGN UP ONLINE!

www.LEGOclub.com

VISIT THE WORLD'S BIGGEST LEGO® SHOP!  
www.LEGOshop.com

GO TO  
www.LEGOclub.com

00800 5346 5555\*

USA Canada 1-866-534-6258 • 1-877-518-5346

US & Canada only Canada seulement



\* Freephone. Mobile charges may apply. \* Numéro sans frais. Des frais peuvent s'appliquer avec les téléphones cellulaires. \* Gebührenfrei. Kosten für Anrufe aus Mobilfunknetzen können abweichen. \* Gratis telefoonnummer vanaf vaste lijn. \* Det er et gratis nummer, når du ringer fra fasttelefon. \* Det är gratis, när du ringer från en fast telefon. \* Numéro sans frais. Des frais peuvent s'appliquer avec les téléphones portables.



# WIN!

Go to [www.LEGOsurvey.com/product](http://www.LEGOsurvey.com/product) to fill out a survey for a chance to win a cool LEGO® Product. No purchase necessary. Open to all residents where not prohibited.



[www.LEGO.com](http://www.LEGO.com)



## [www.LEGOsurvey.com/product](http://www.LEGOsurvey.com/product)

### GEWINNE!

Nimm an der Umfrage auf [www.LEGOsurvey.com/product](http://www.LEGOsurvey.com/product) teil und hab die Chance ein cooles LEGO® Produkt zu gewinnen!

Die Teilnahme am Gewinnspiel führt zu keinerlei Kaufverpflichtungen. Teilnahme in allen nicht ausgeschlossenen Ländern möglich.

### WIN!

Ga naar [www.LEGOsurvey.com/product](http://www.LEGOsurvey.com/product), vul een enquêteformulier in en maak kans op een cool LEGO® product.

Geen aankoopverplichting. Iedereen mag deelnemen, uitgezonderd ingezetenden van landen waar een enquêteverbod geldt.

### GAGNE!

Visite [www.LEGOsurvey.com/product](http://www.LEGOsurvey.com/product) pour répondre à un questionnaire et avoir une chance de gagner un produit LEGO® très cool!

Aucune obligation d'achat. Ouvert à tous les résidents des pays autorisés.

### 当てよう!

[www.LEGOsurvey.com/product](http://www.LEGOsurvey.com/product) にアクセスして、アンケートにご記入ください。当選者にはレゴ®製品を差し上げます。

お買い上げの必要はありません。禁止されていない限り、すべての皆様にご利用いただけます。



# NINJAGO

Masters of Spinjitzu



2011