

3433

LEGO

SPORTS



! **WARNING: CHOKING HAZARD.**
Toy contains small parts and a small ball.
Not for children under 3 years.

4195758



3427





3560			
3561			
3562			
3563			
3564			
3565			
3566			
3567			



! AVERTISSEMENT : RISQUE D'ÉTOUFFEMENT.

Le jouet contient des petites pièces ainsi qu'une petite boule.
Il ne convient pas aux enfants de moins de 3 ans.

! ADVERTENCIA: PELIGRO DE ASFIXIA.

Juguete que contiene partes pequeñas y una pelota pequeña.
No recomendado para niños menores de 3 años.



1

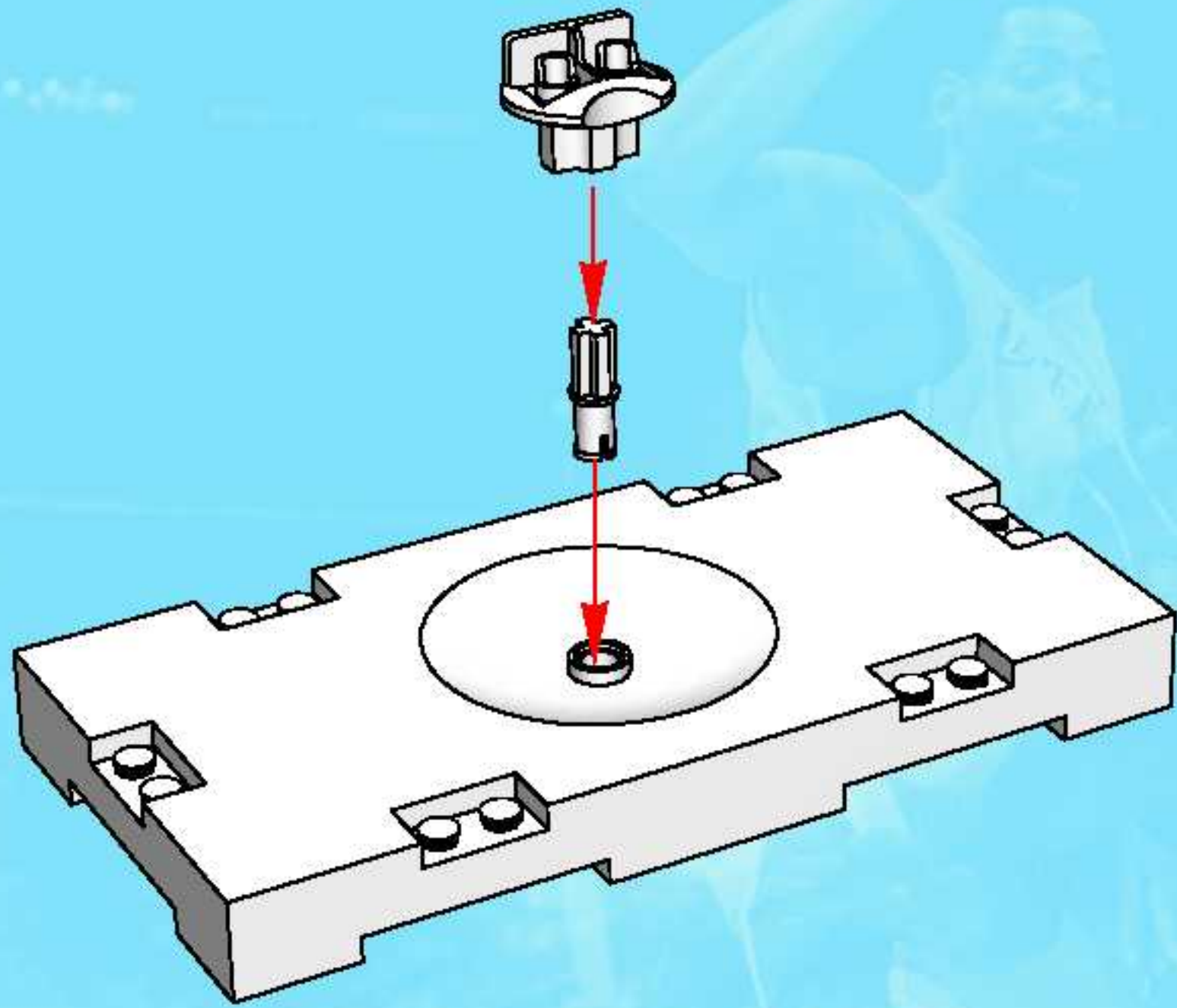

2

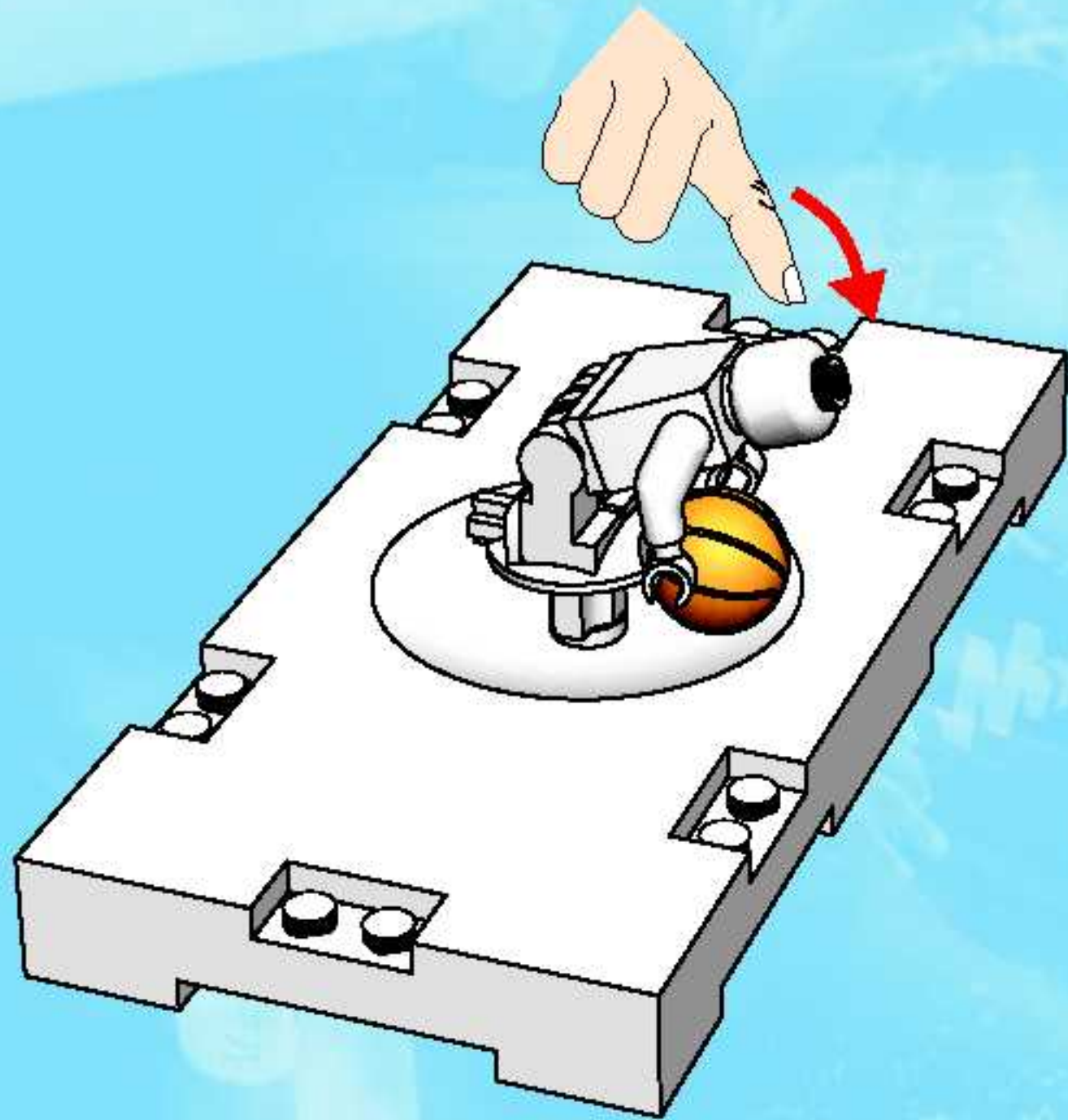

3

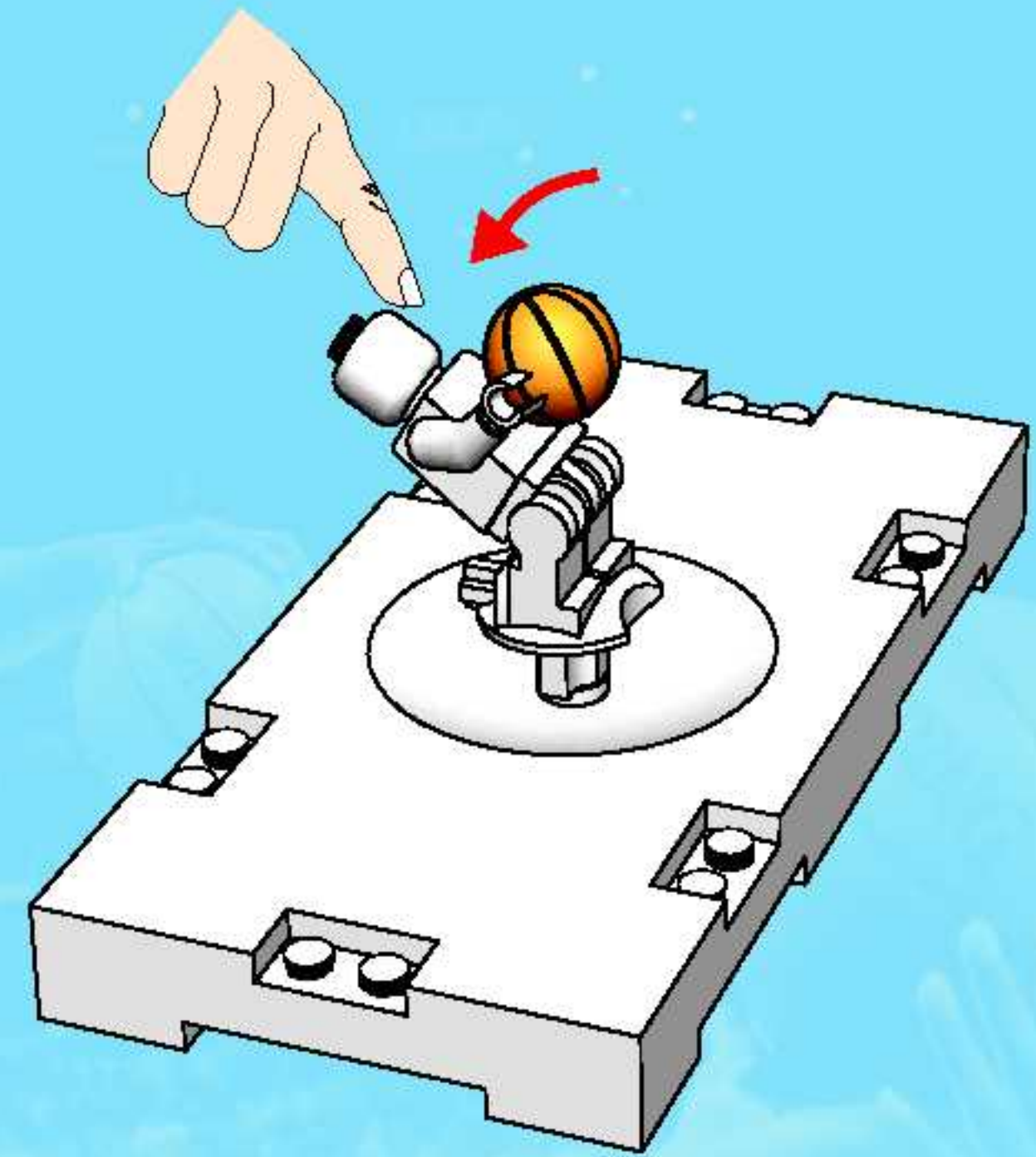

4

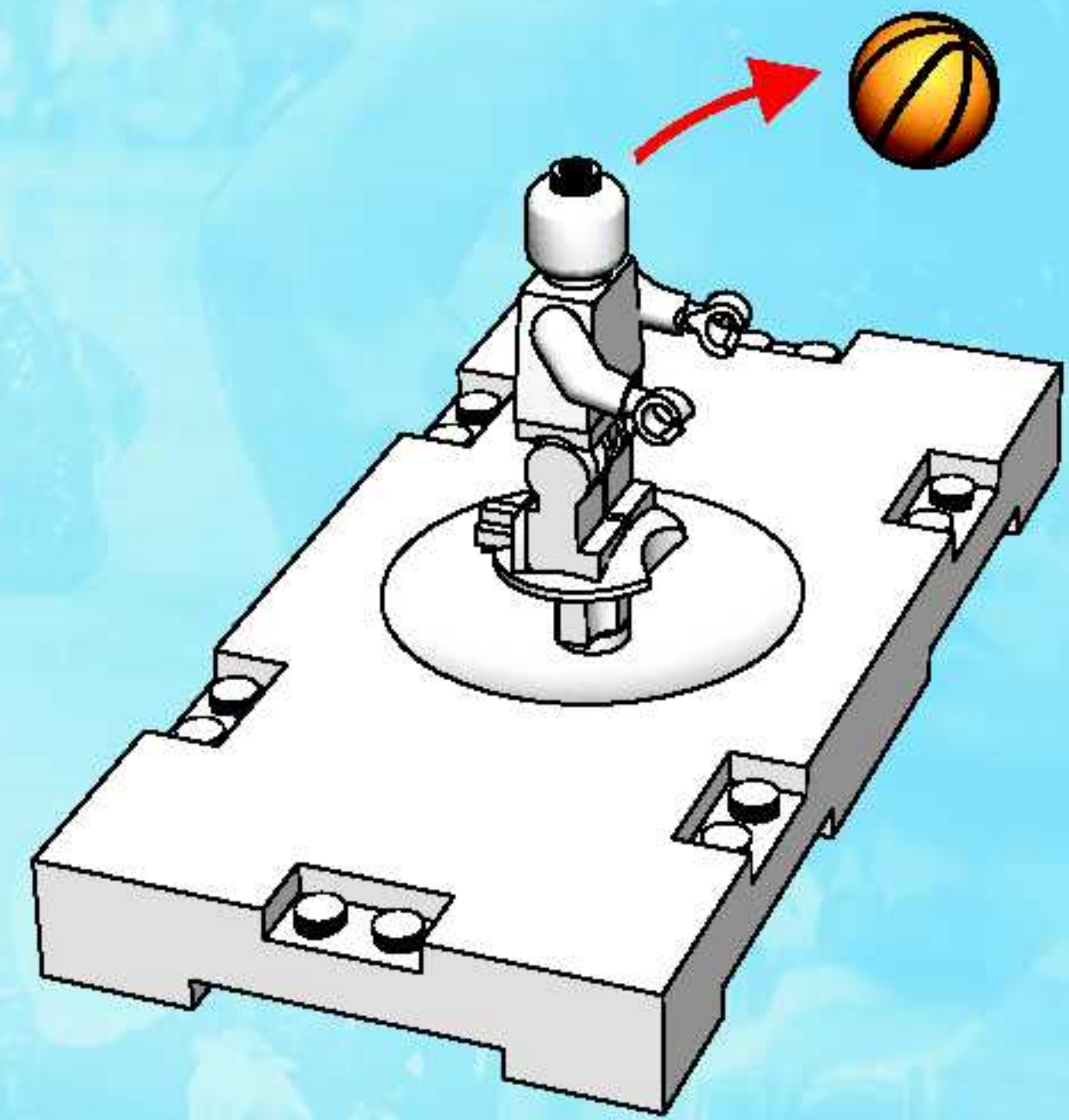

1

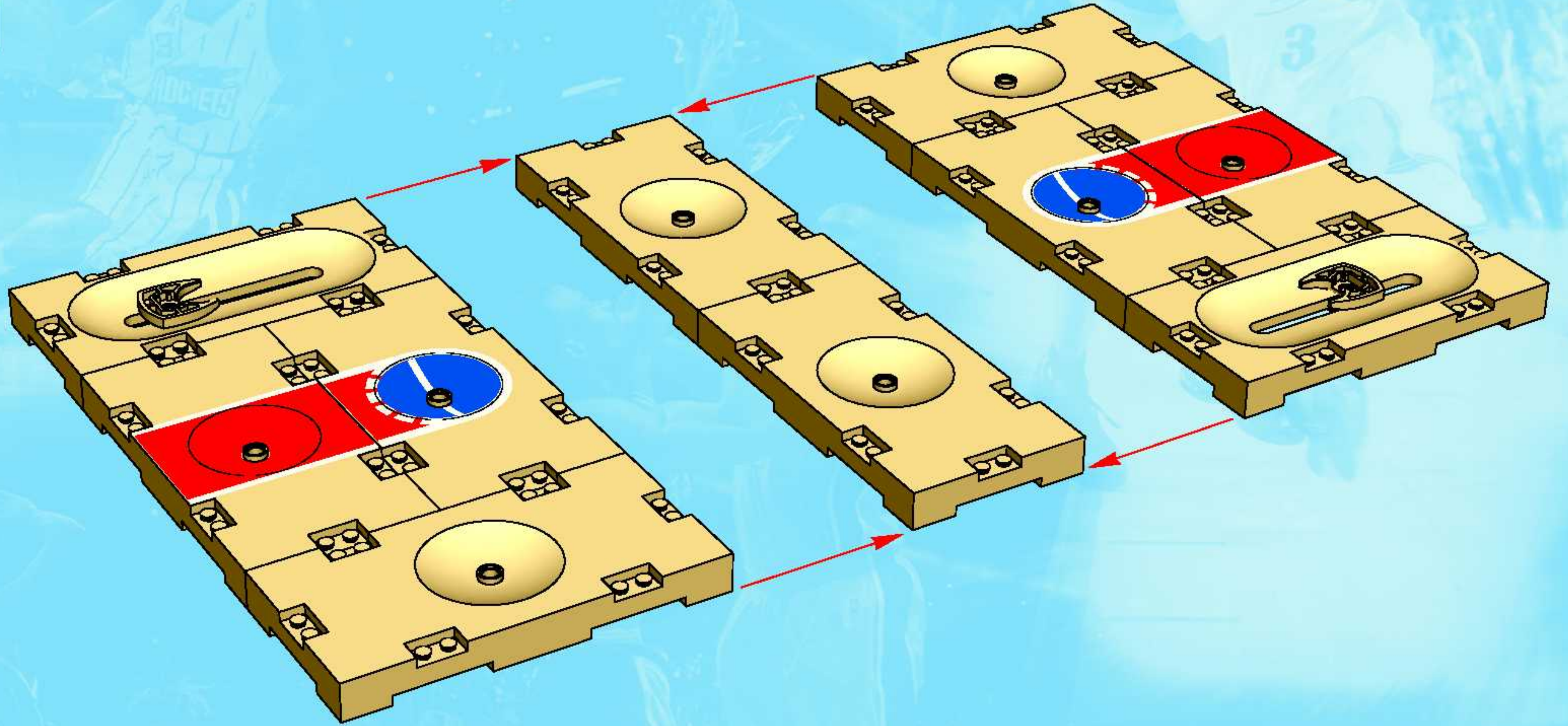

2

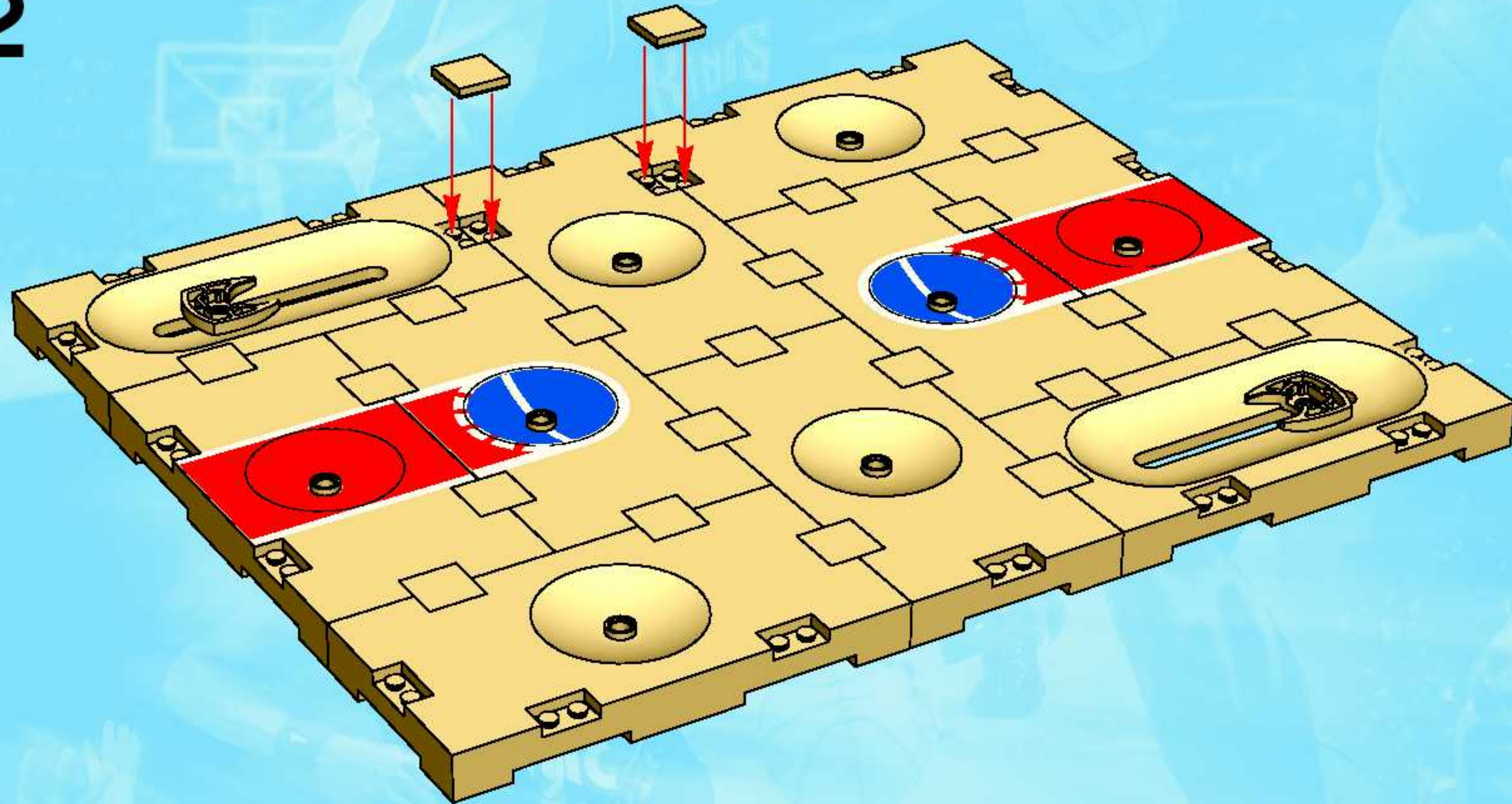

3

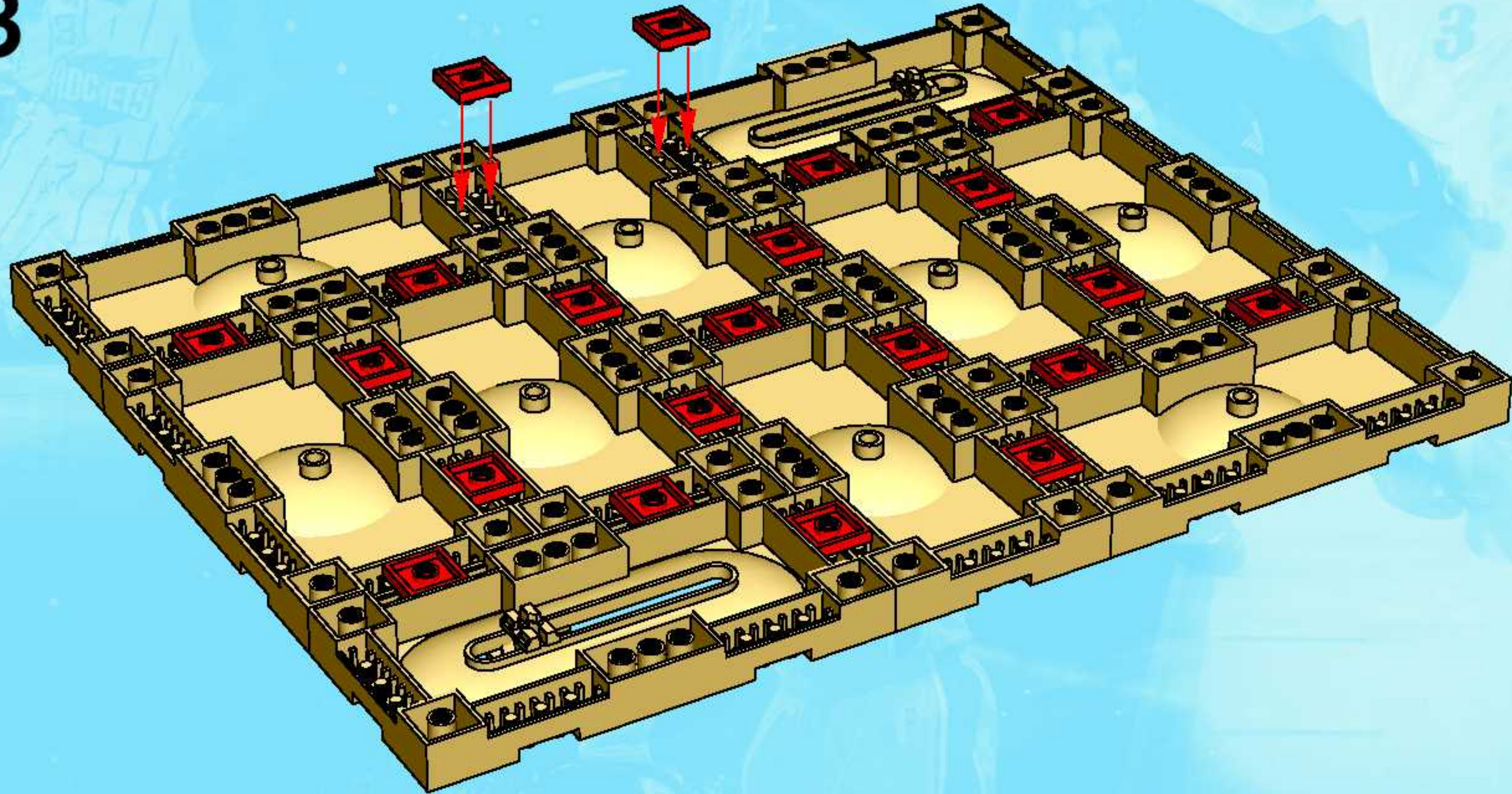

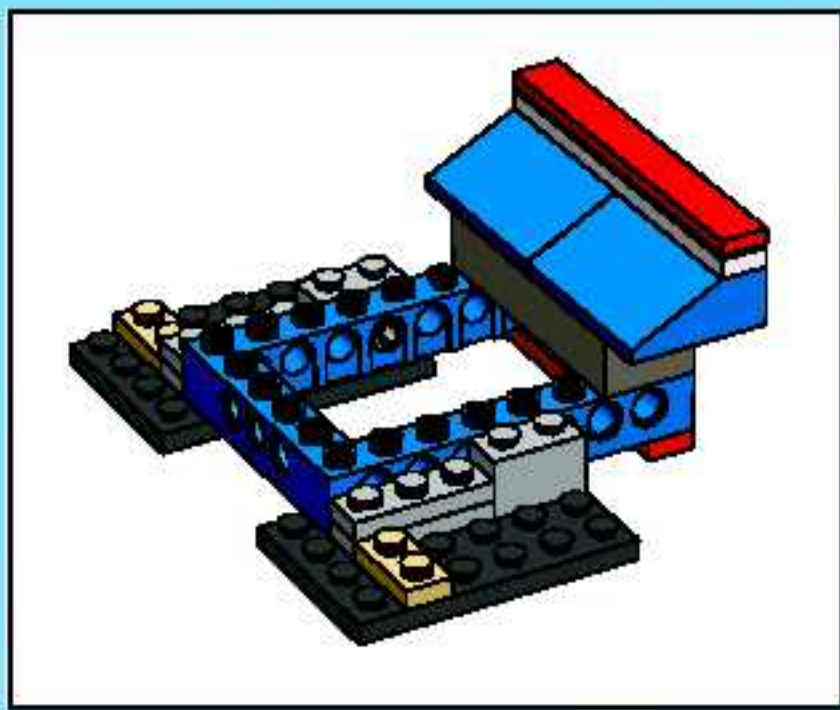

1

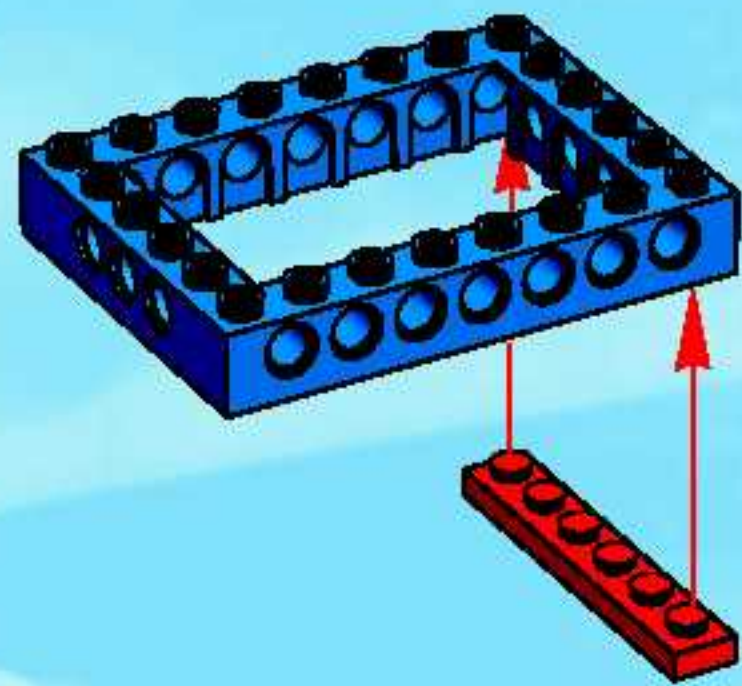

2

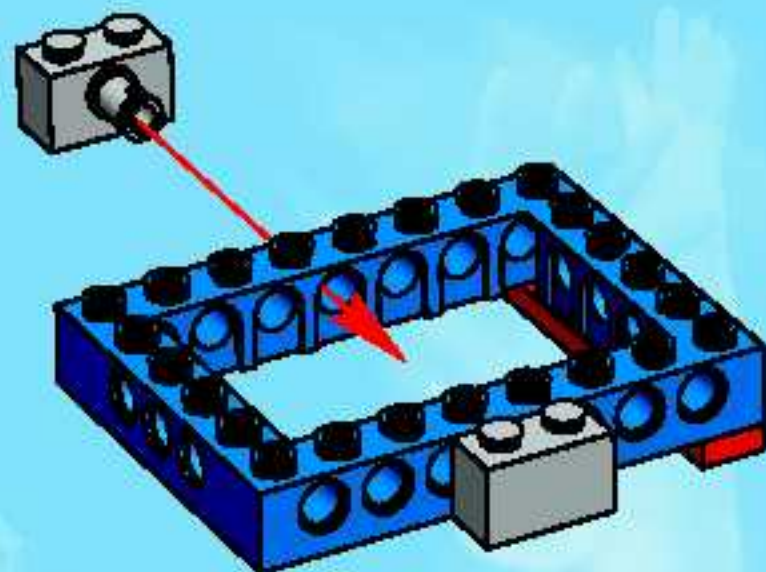

3

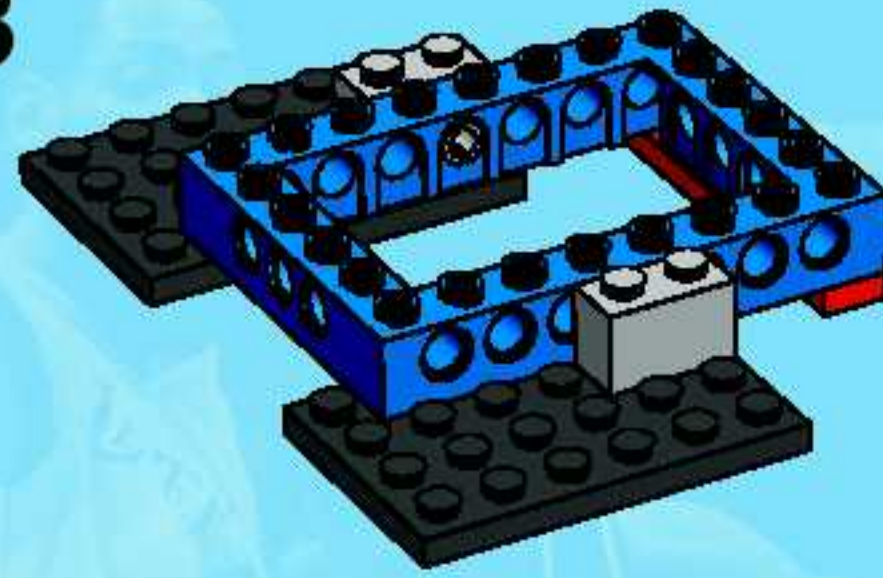

4

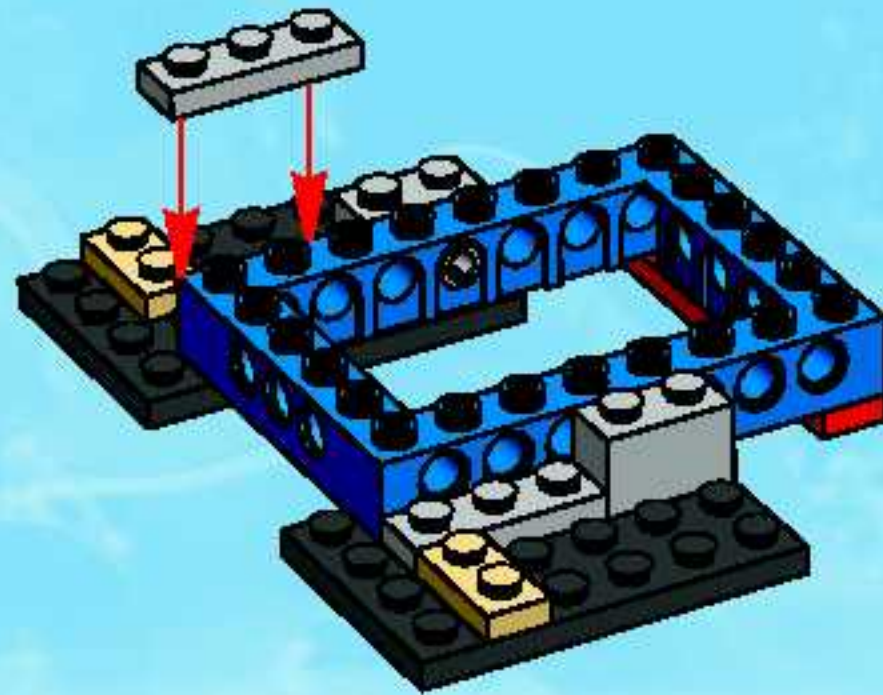

5

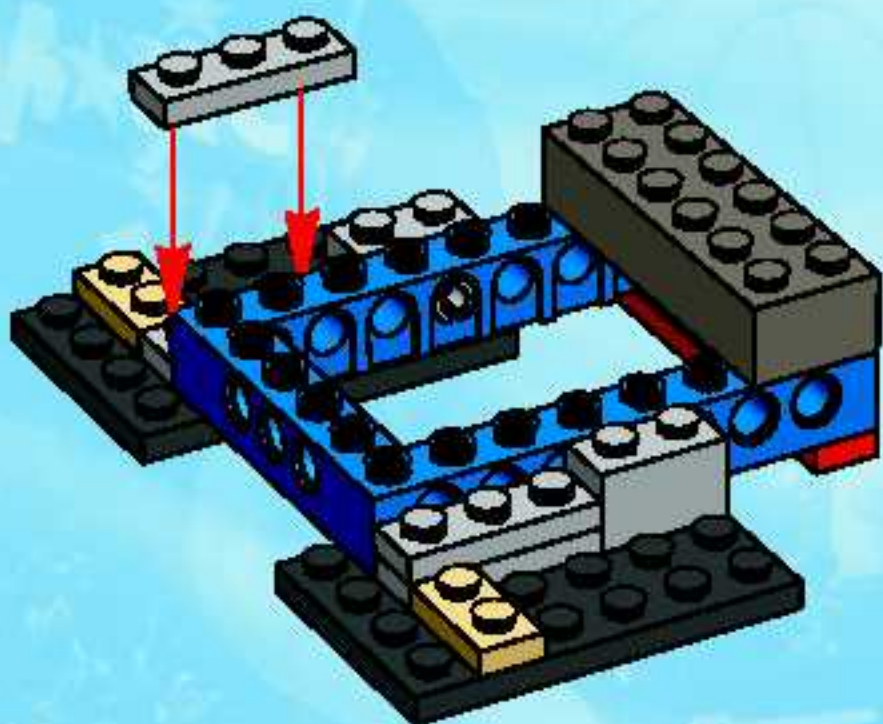

6

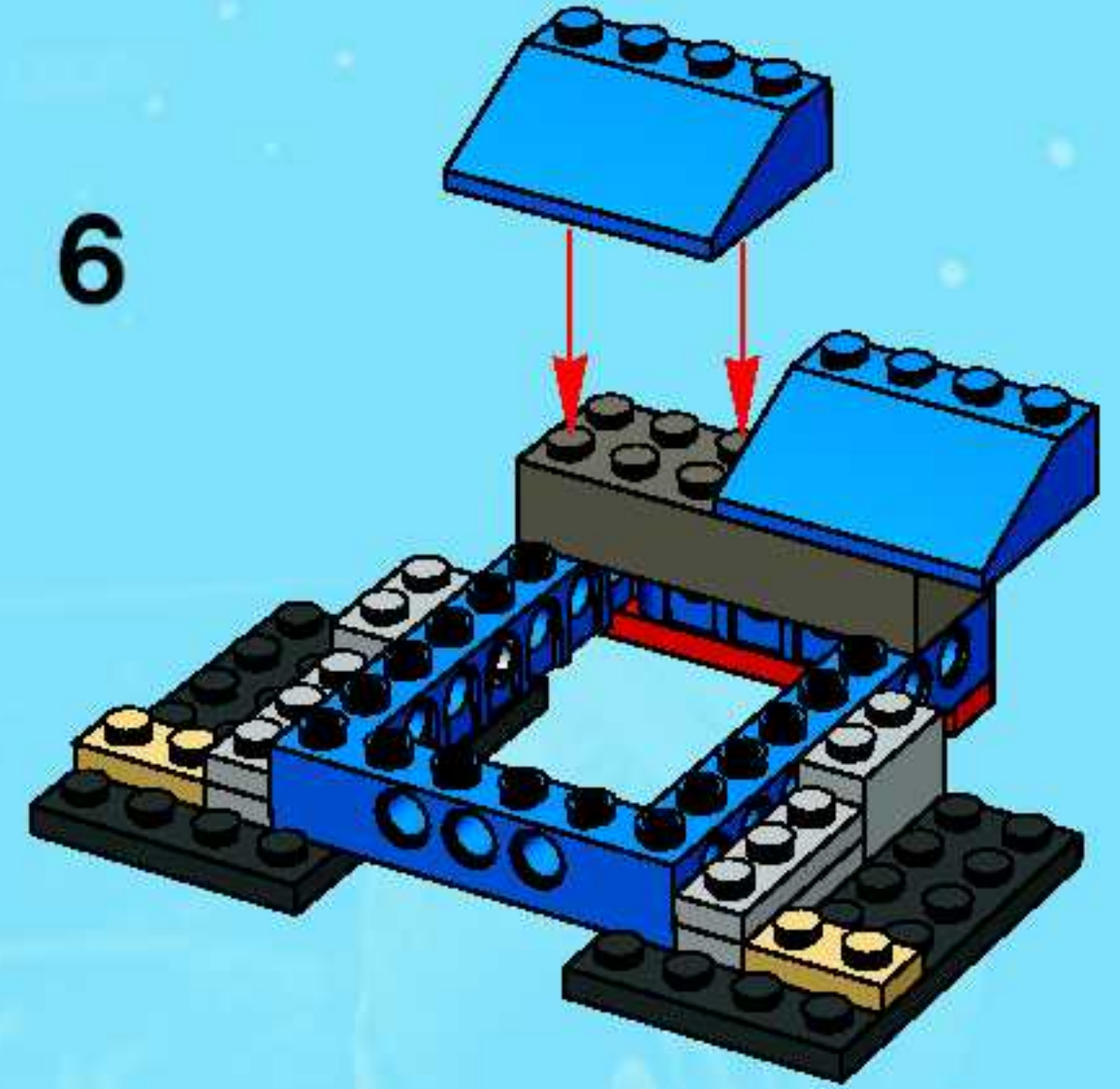

7

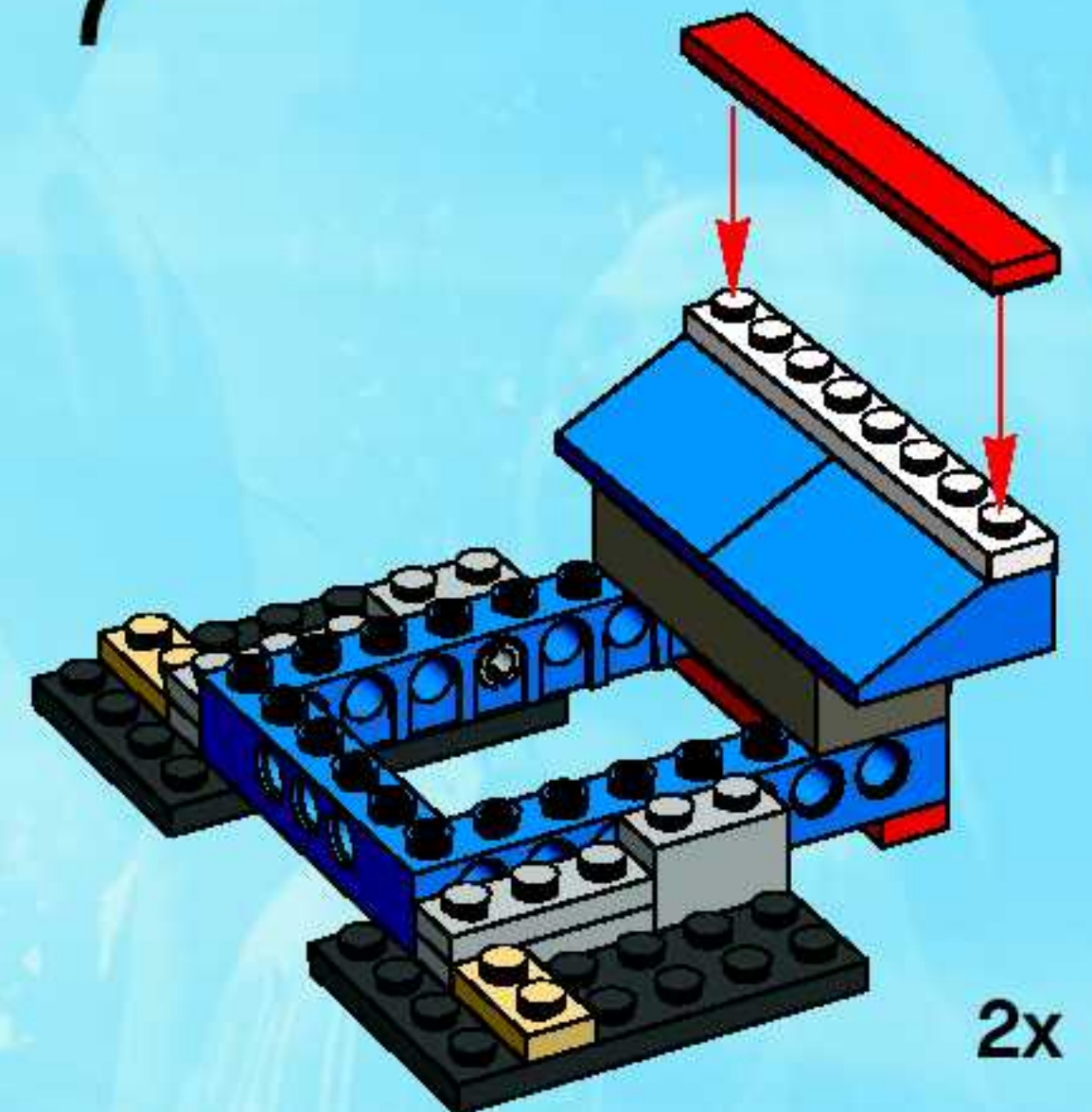

2x

4

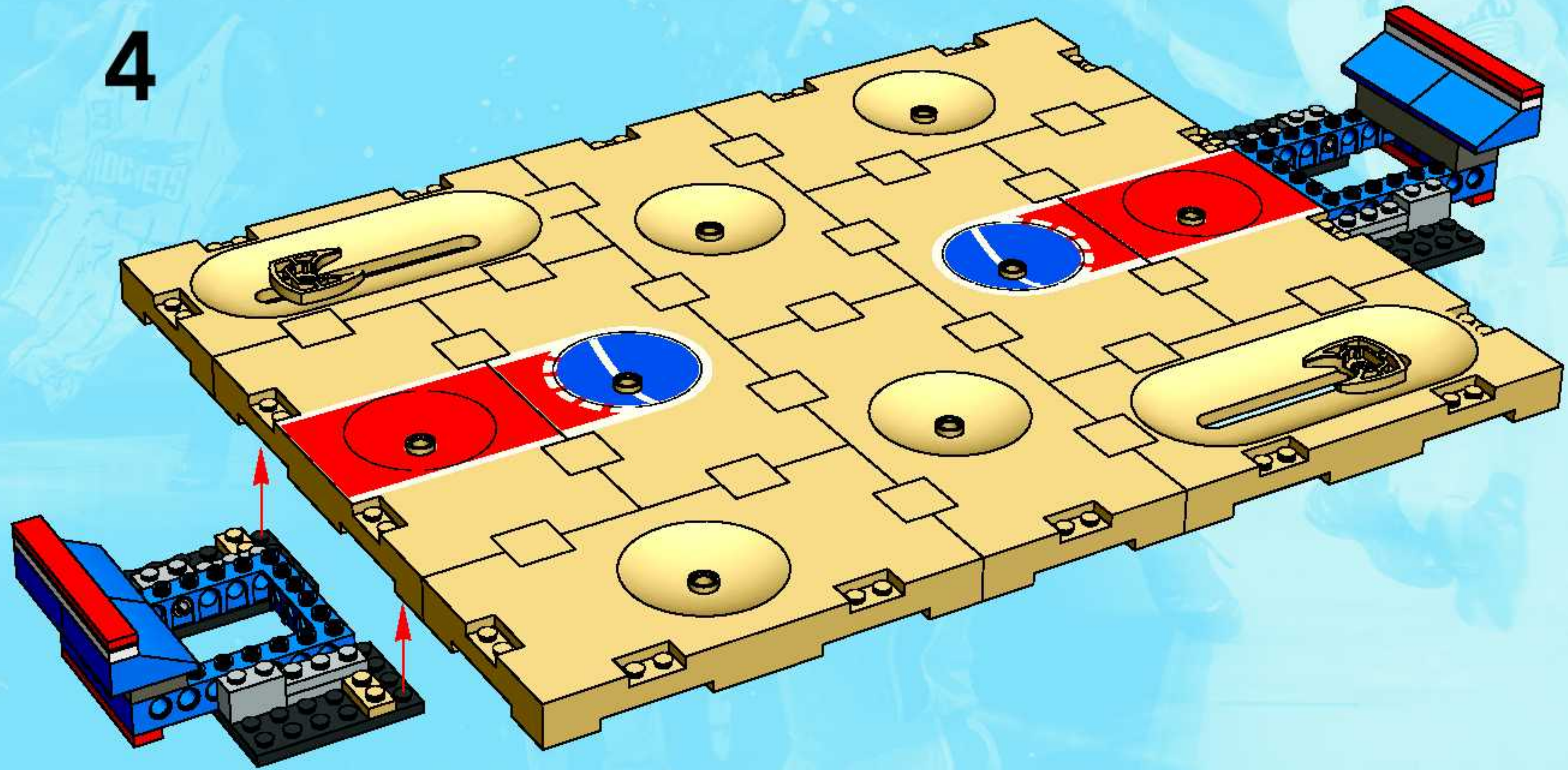

5

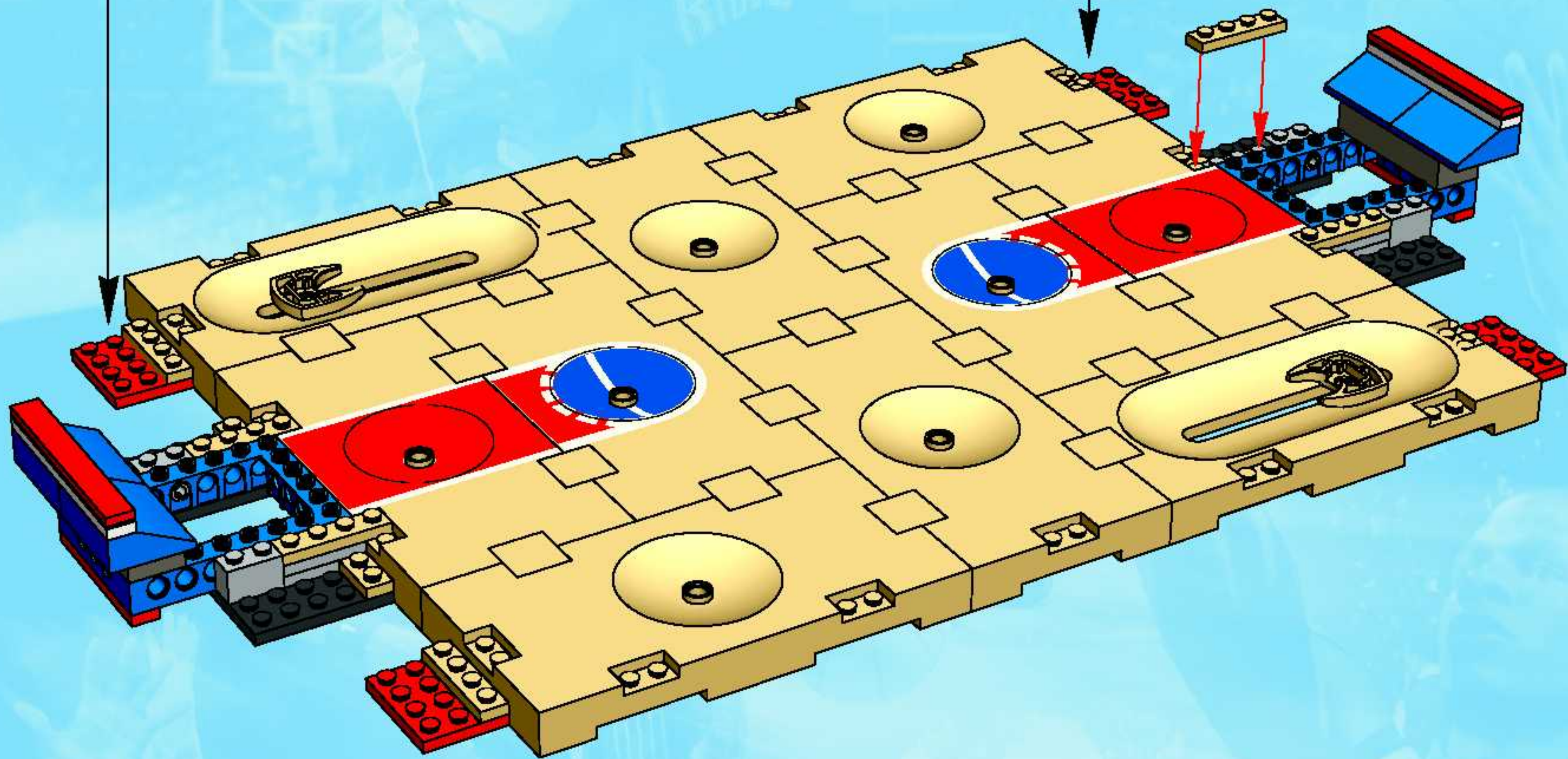
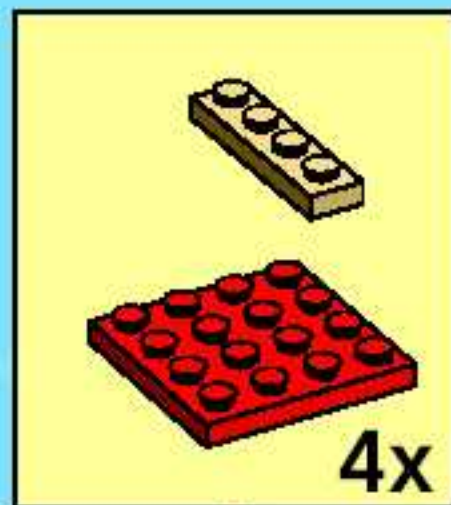

6

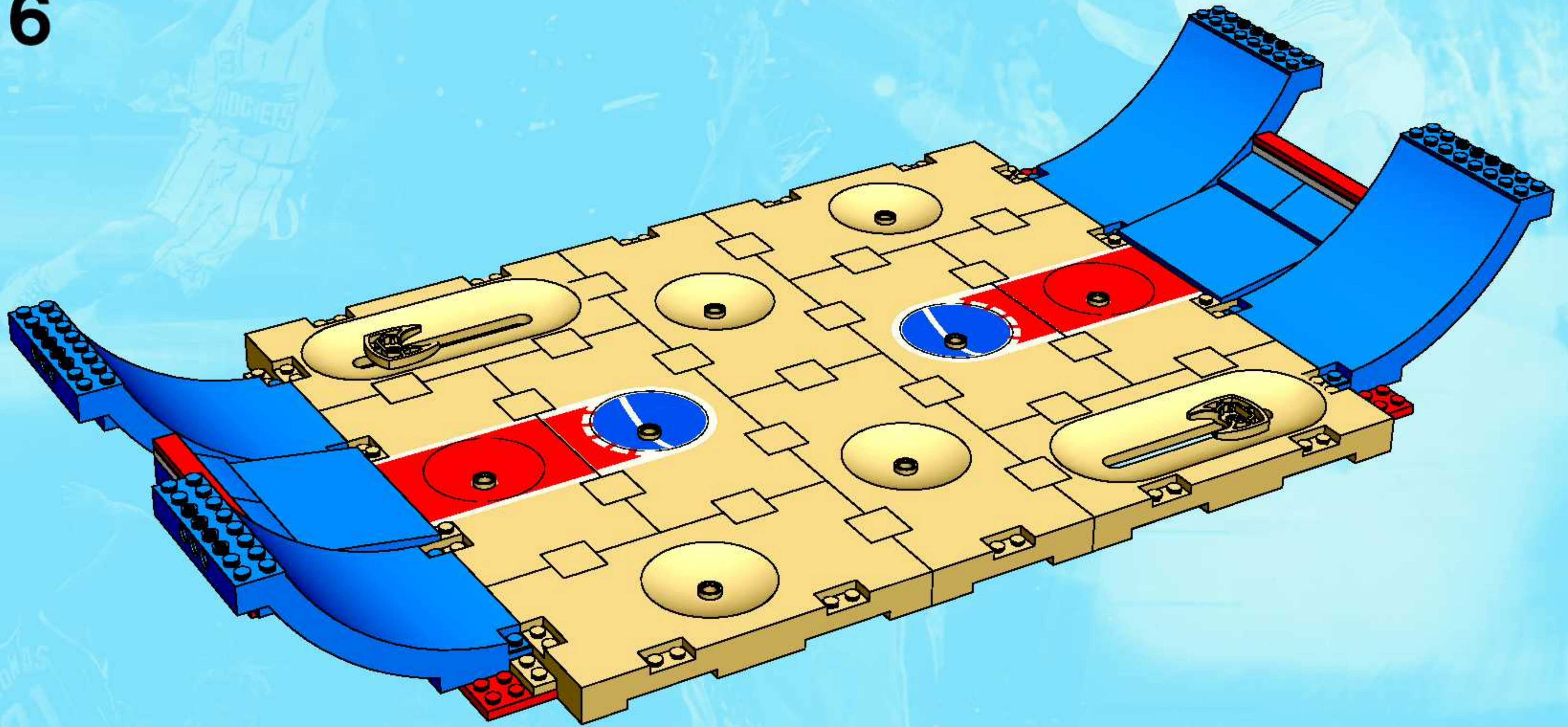

7

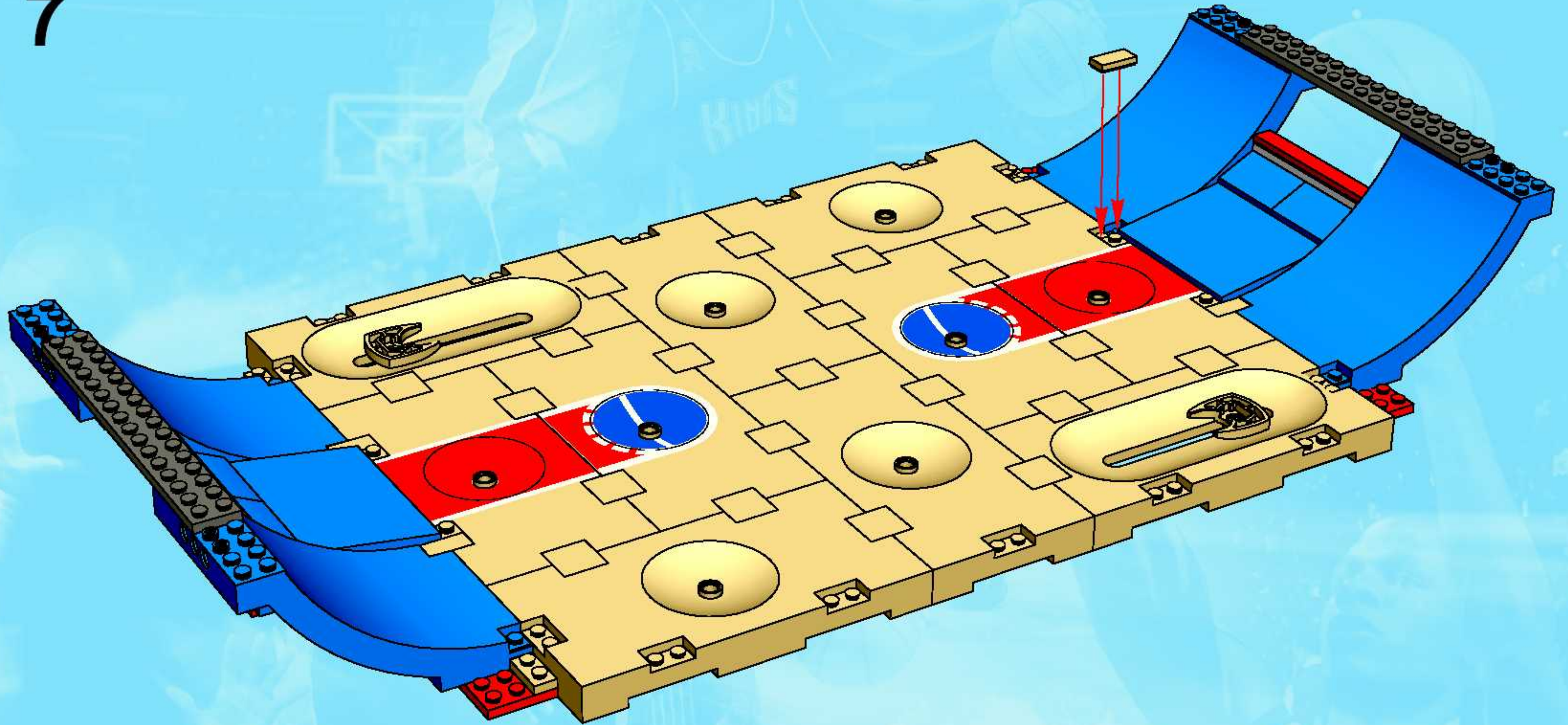

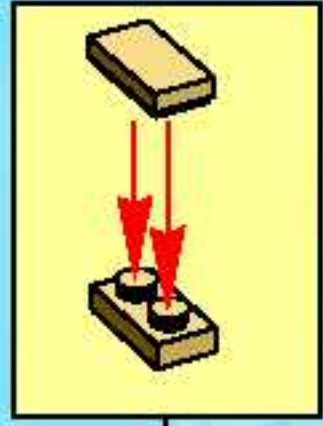
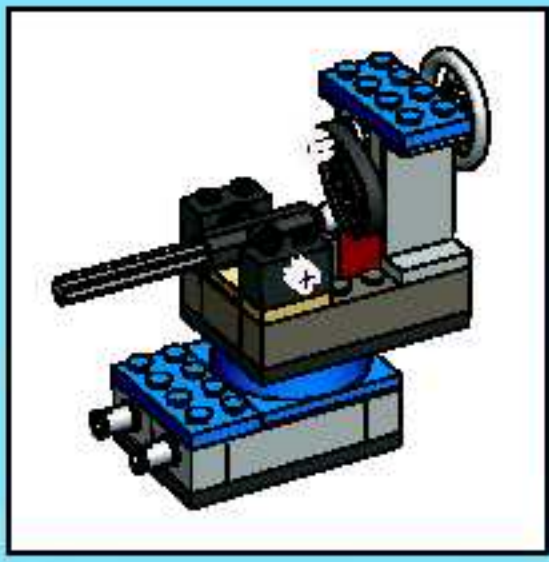

1



2

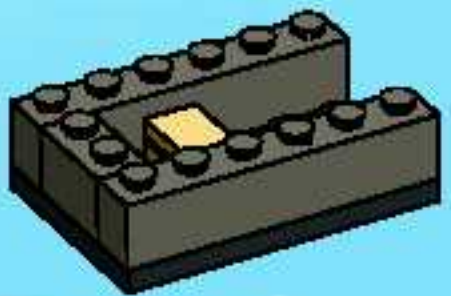

3

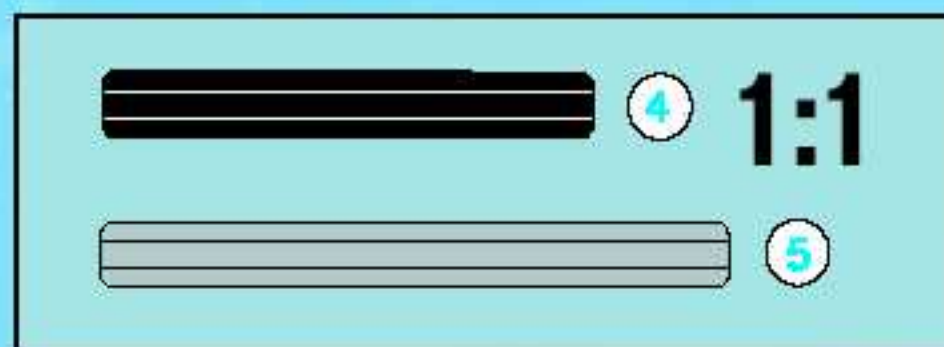
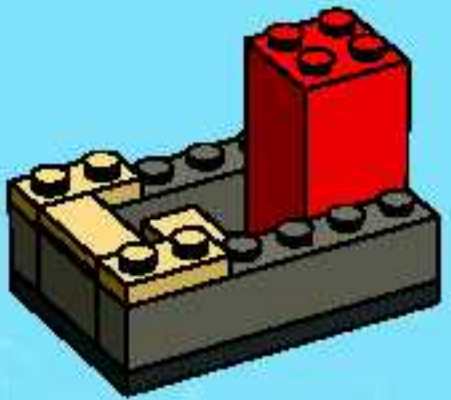

4



5

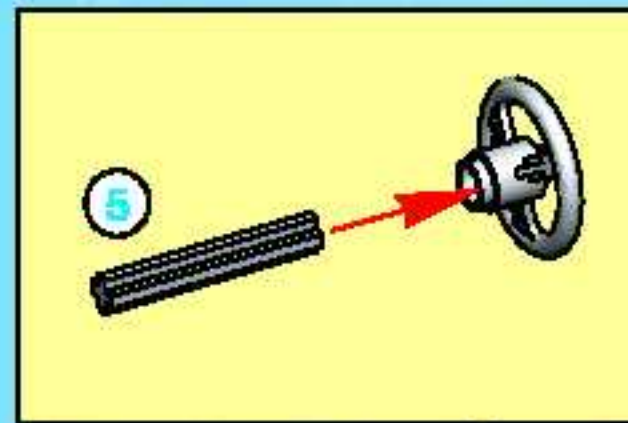

6

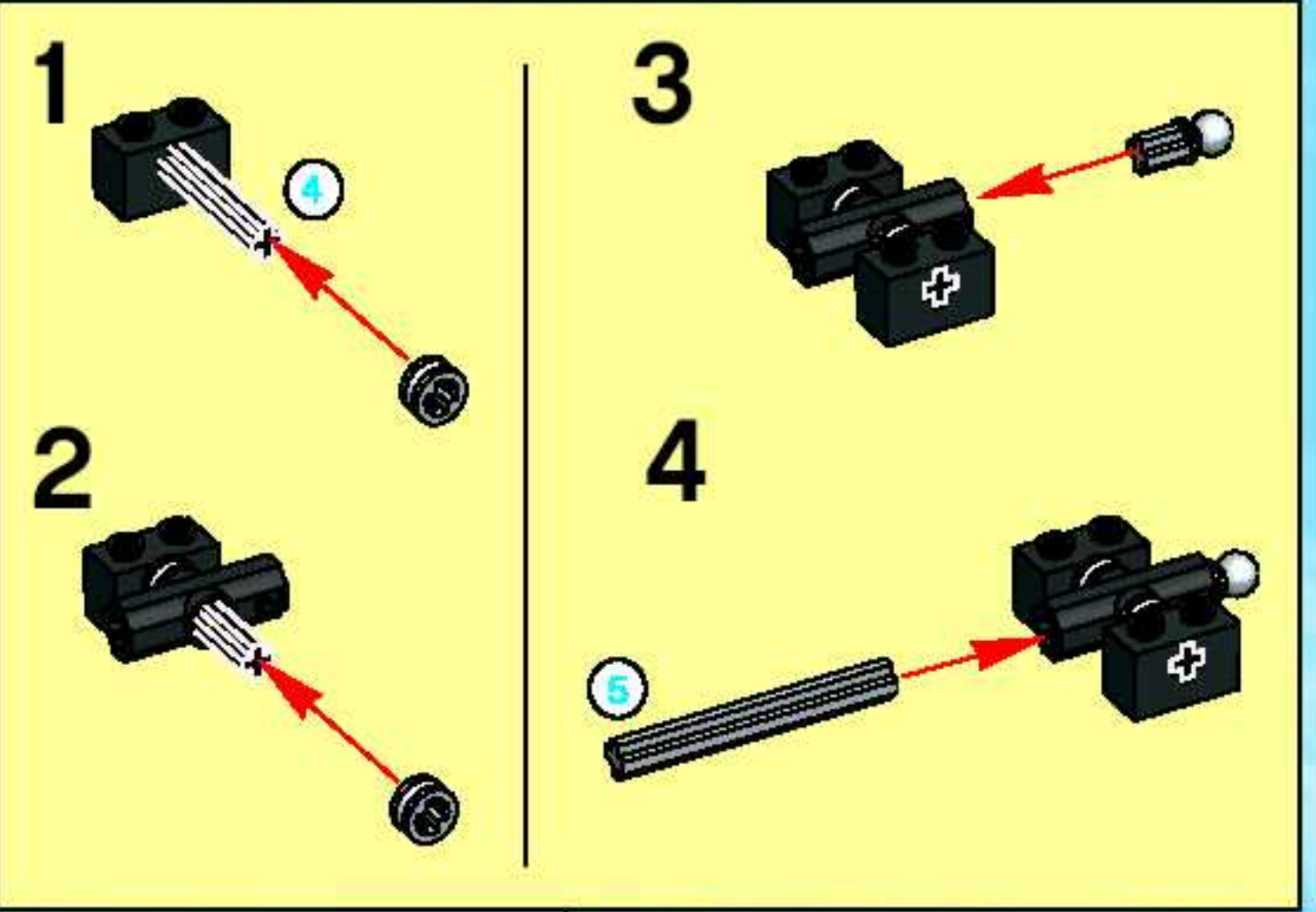
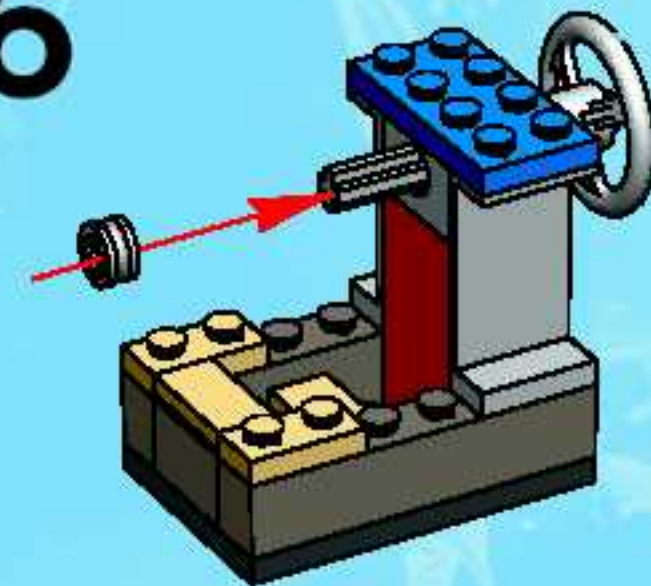

7

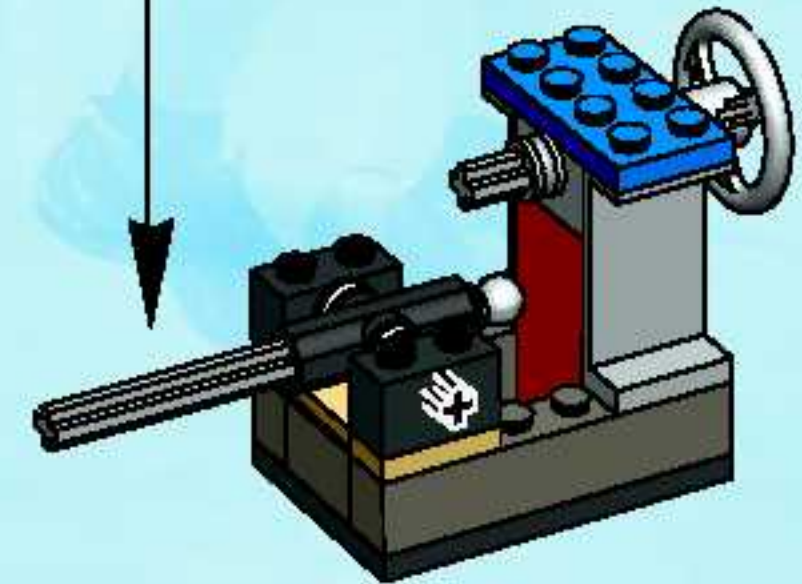

8

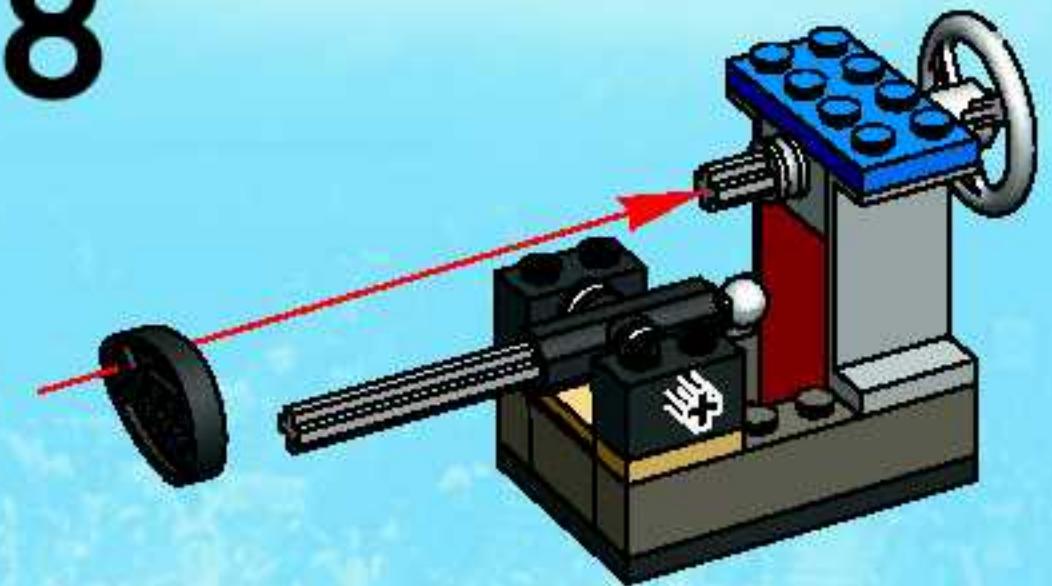

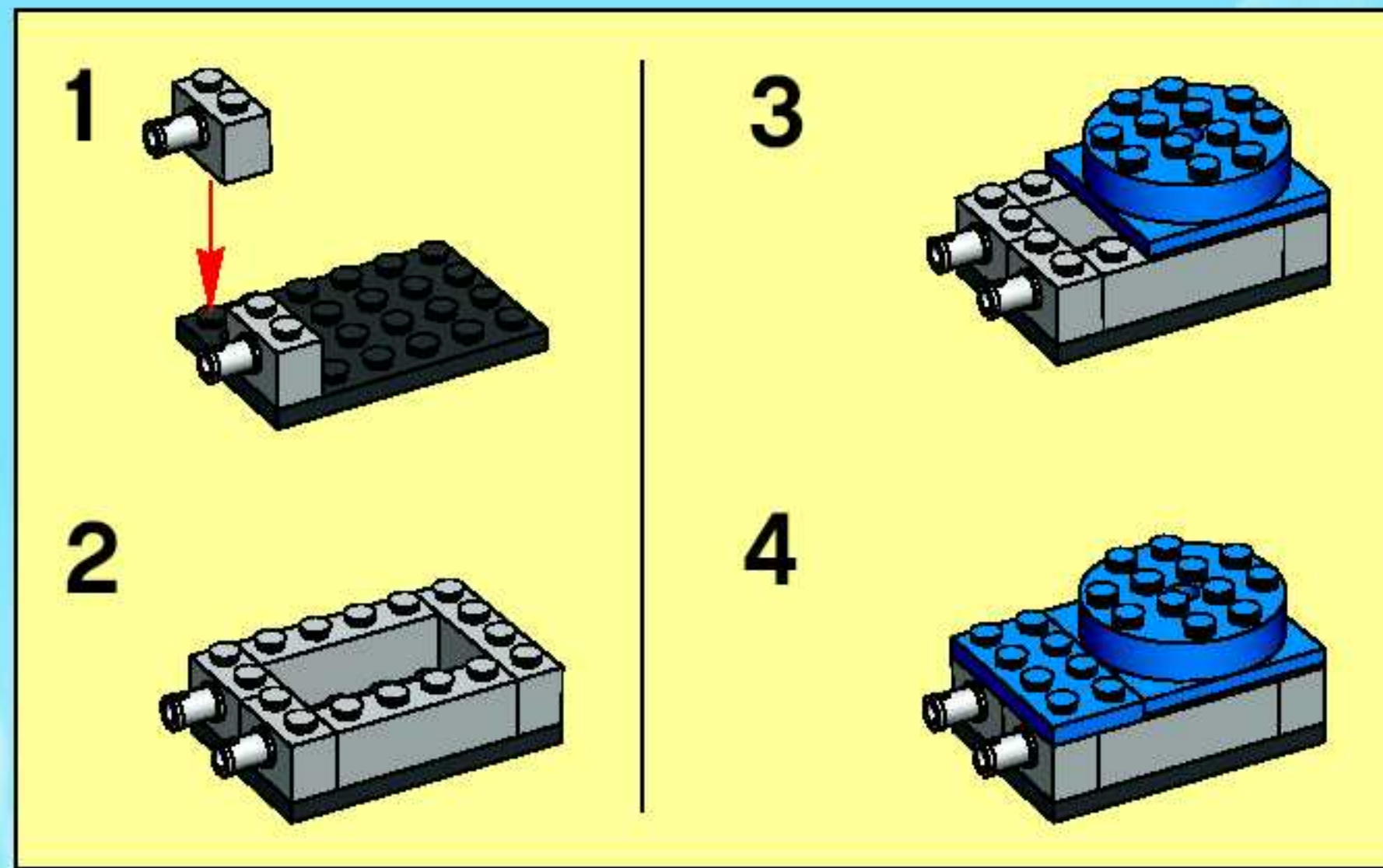

9

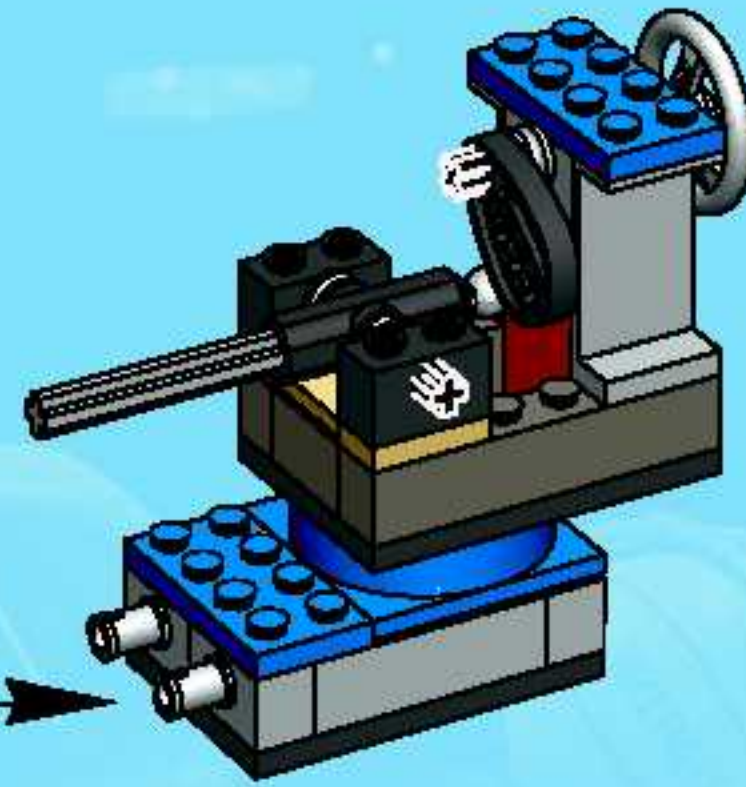

2x

8

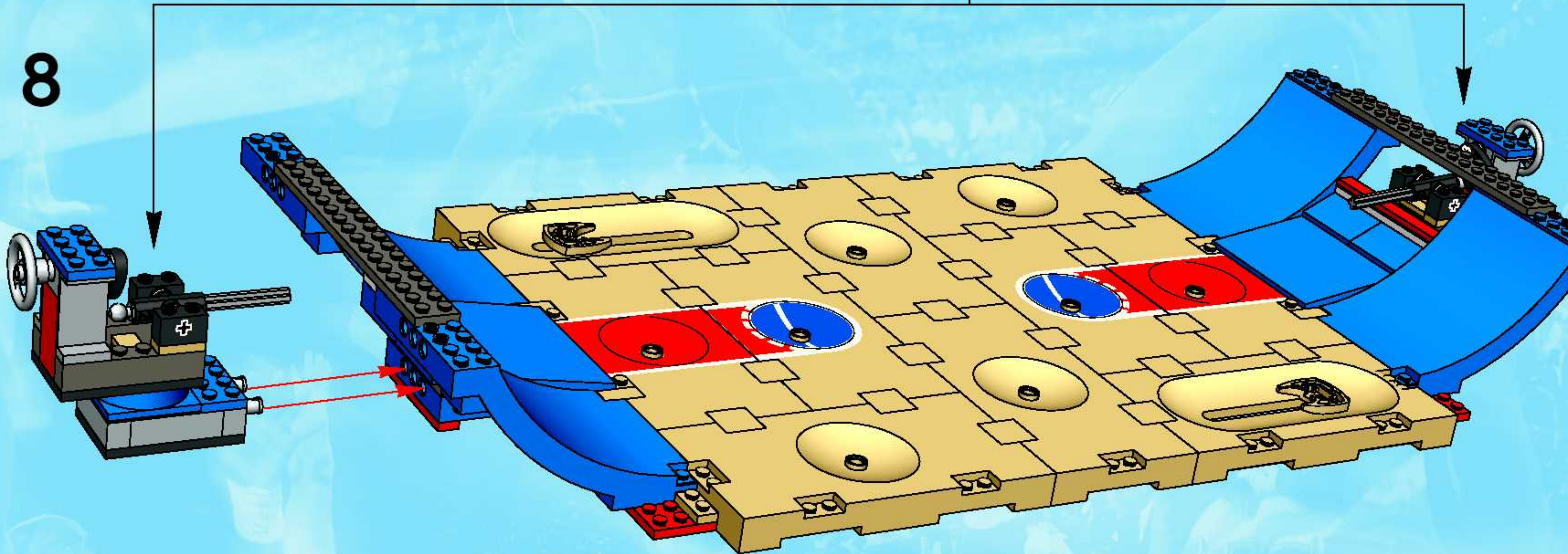

9

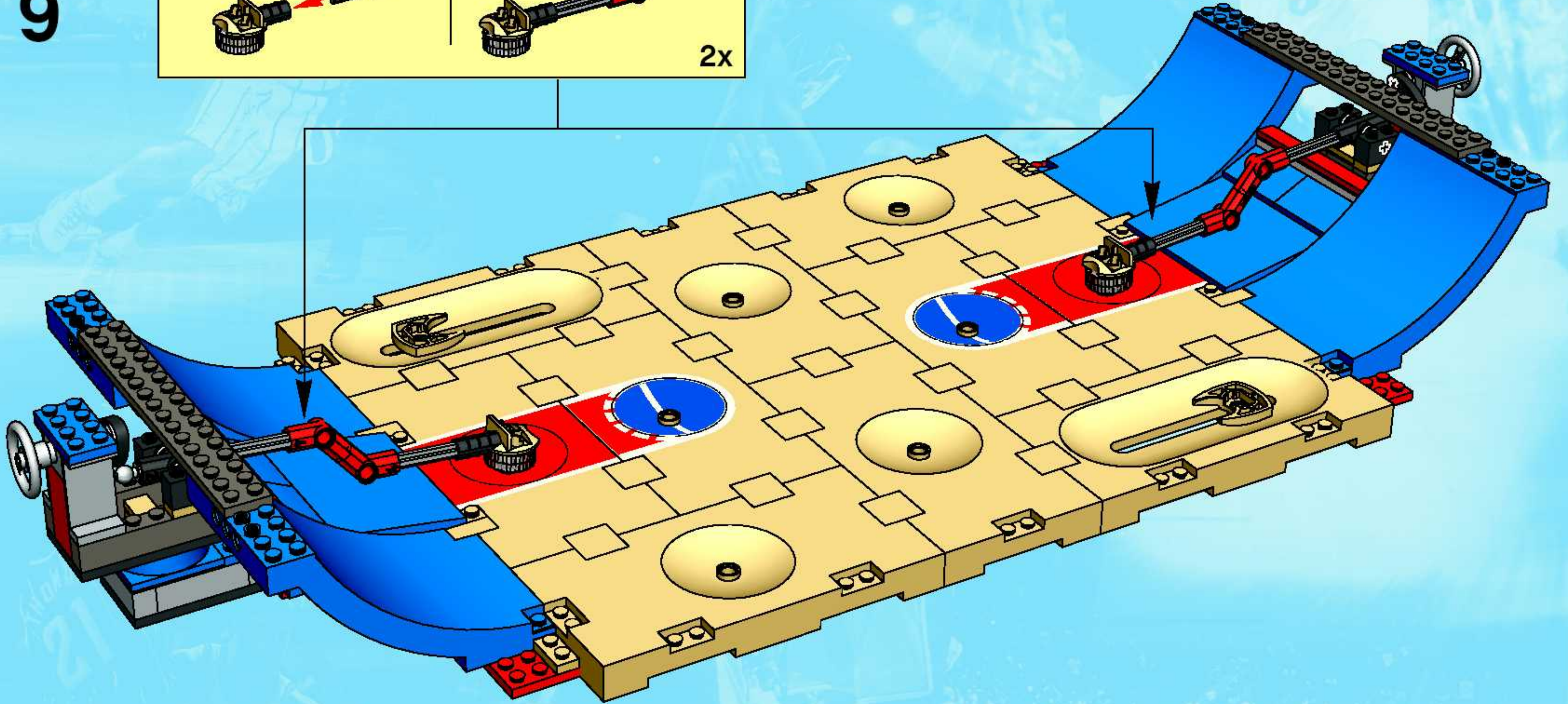
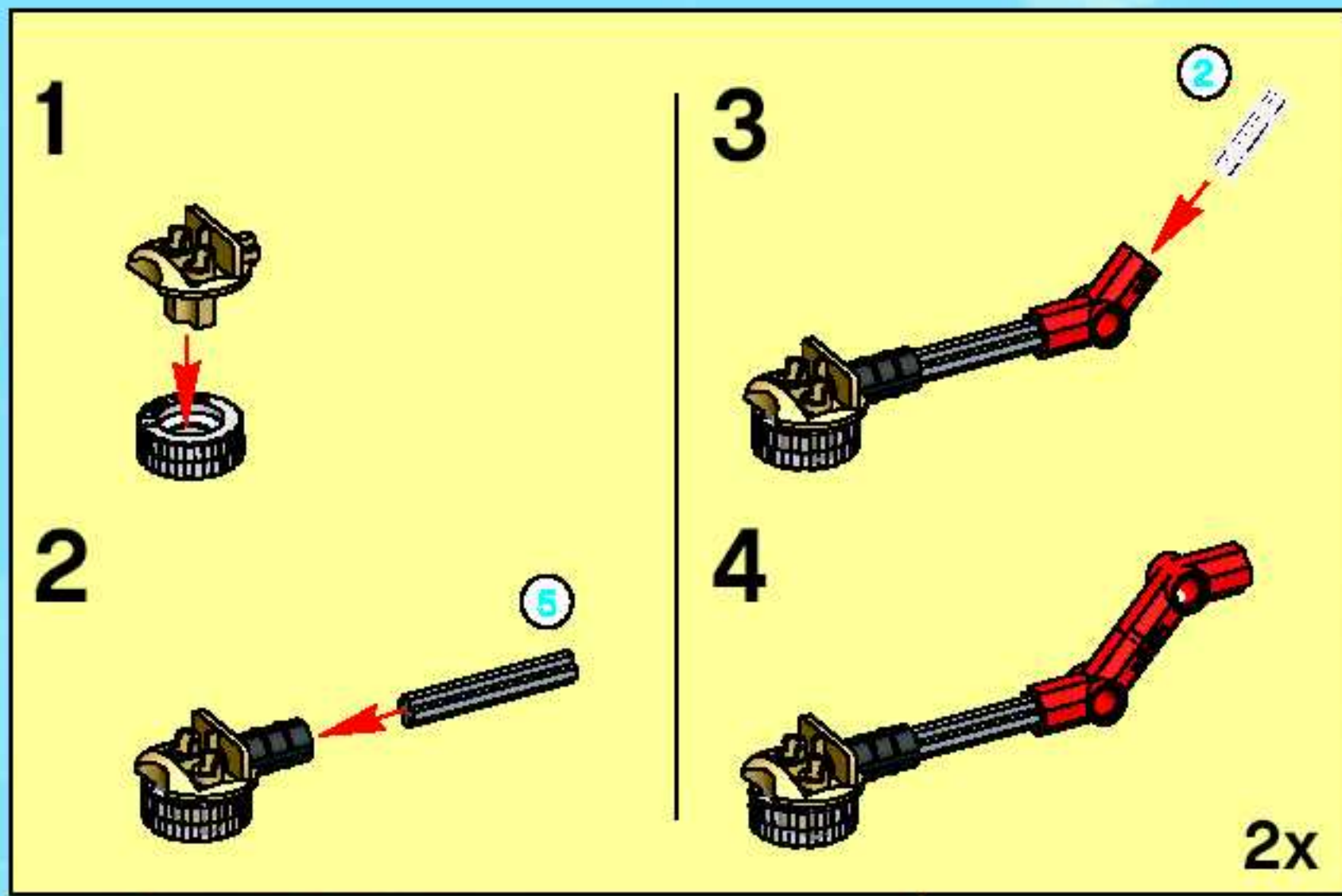

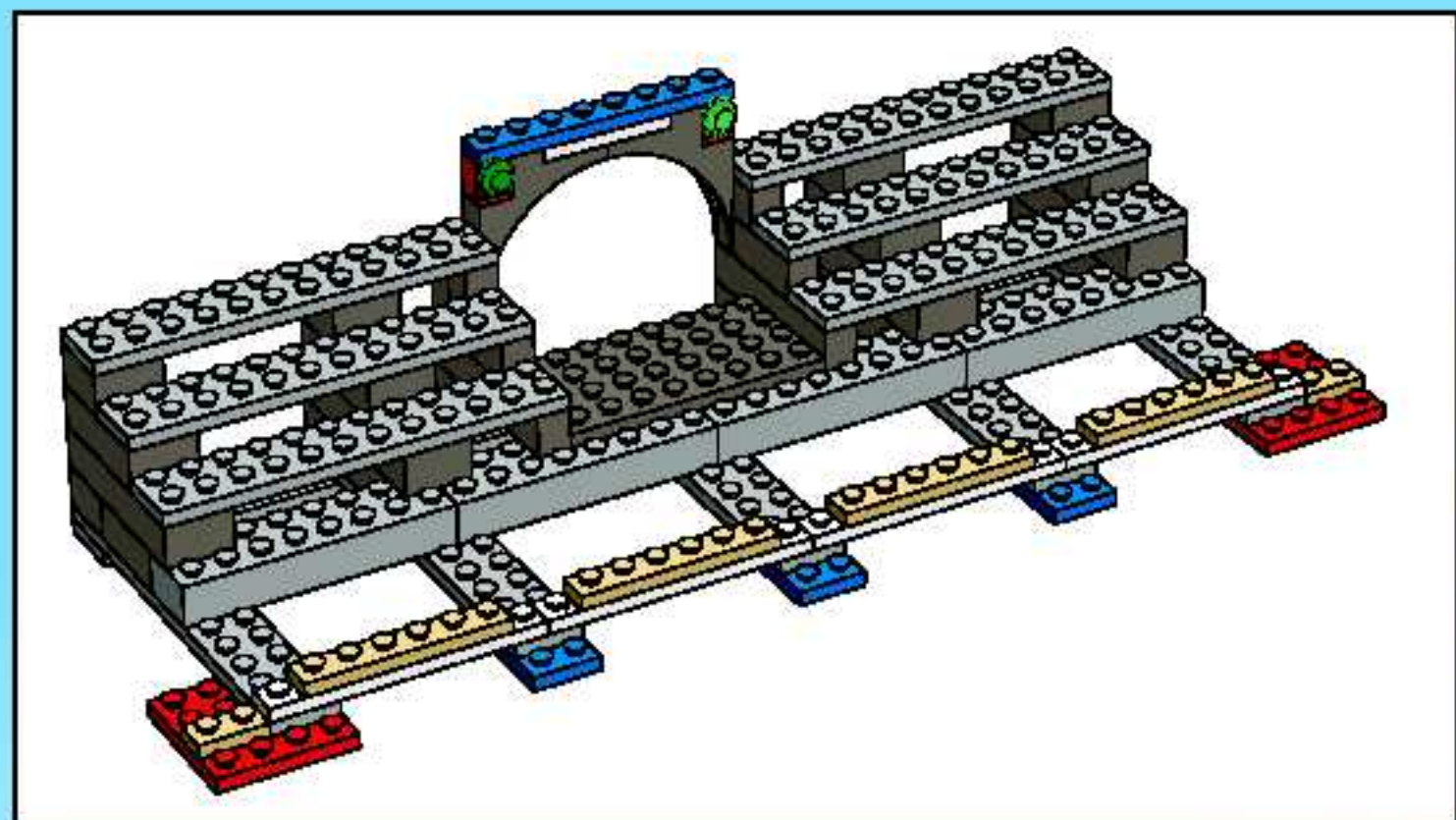

1

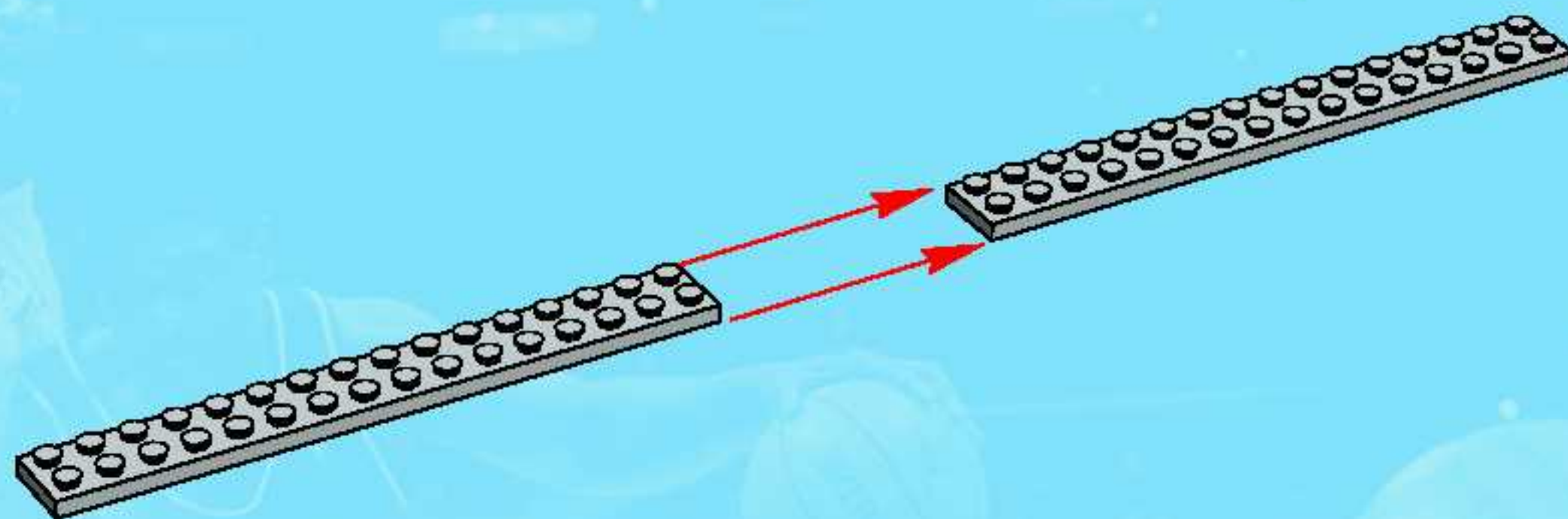

2

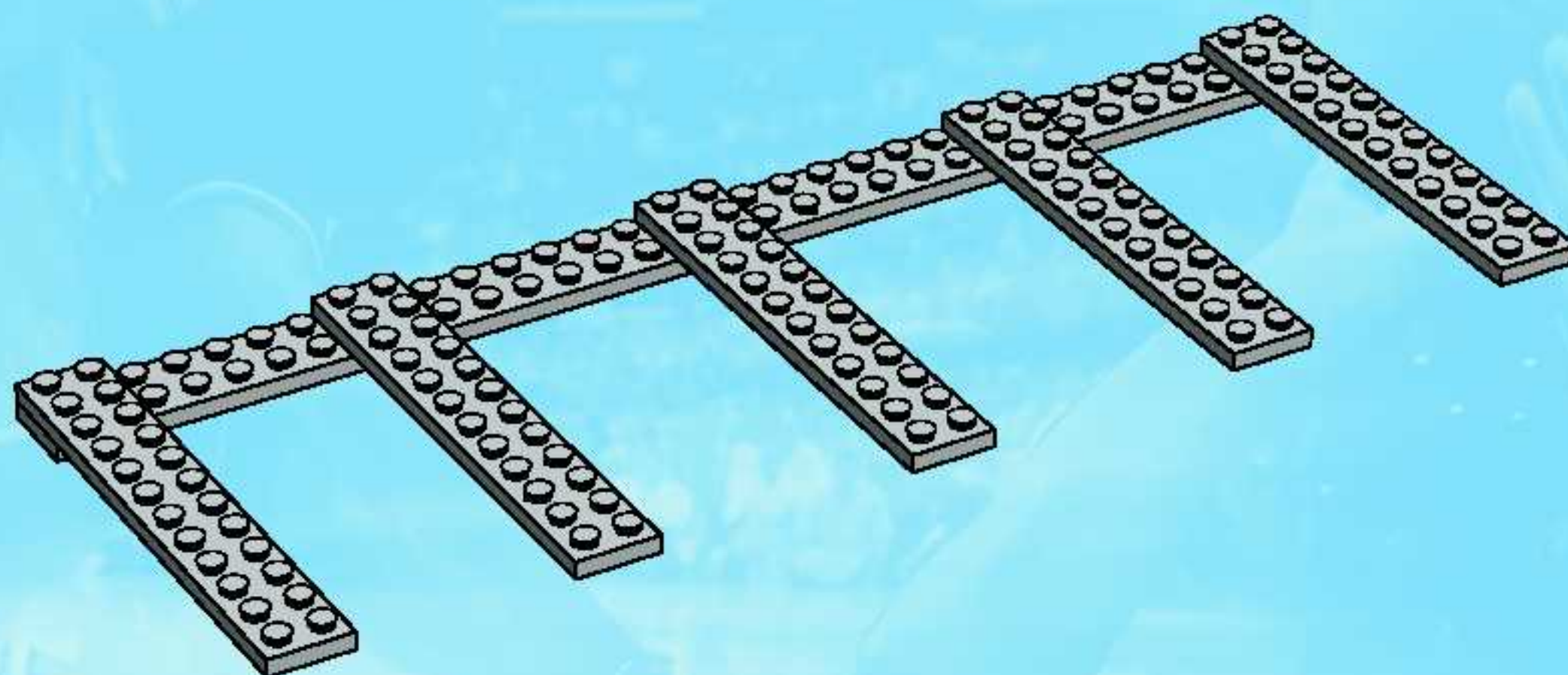

3

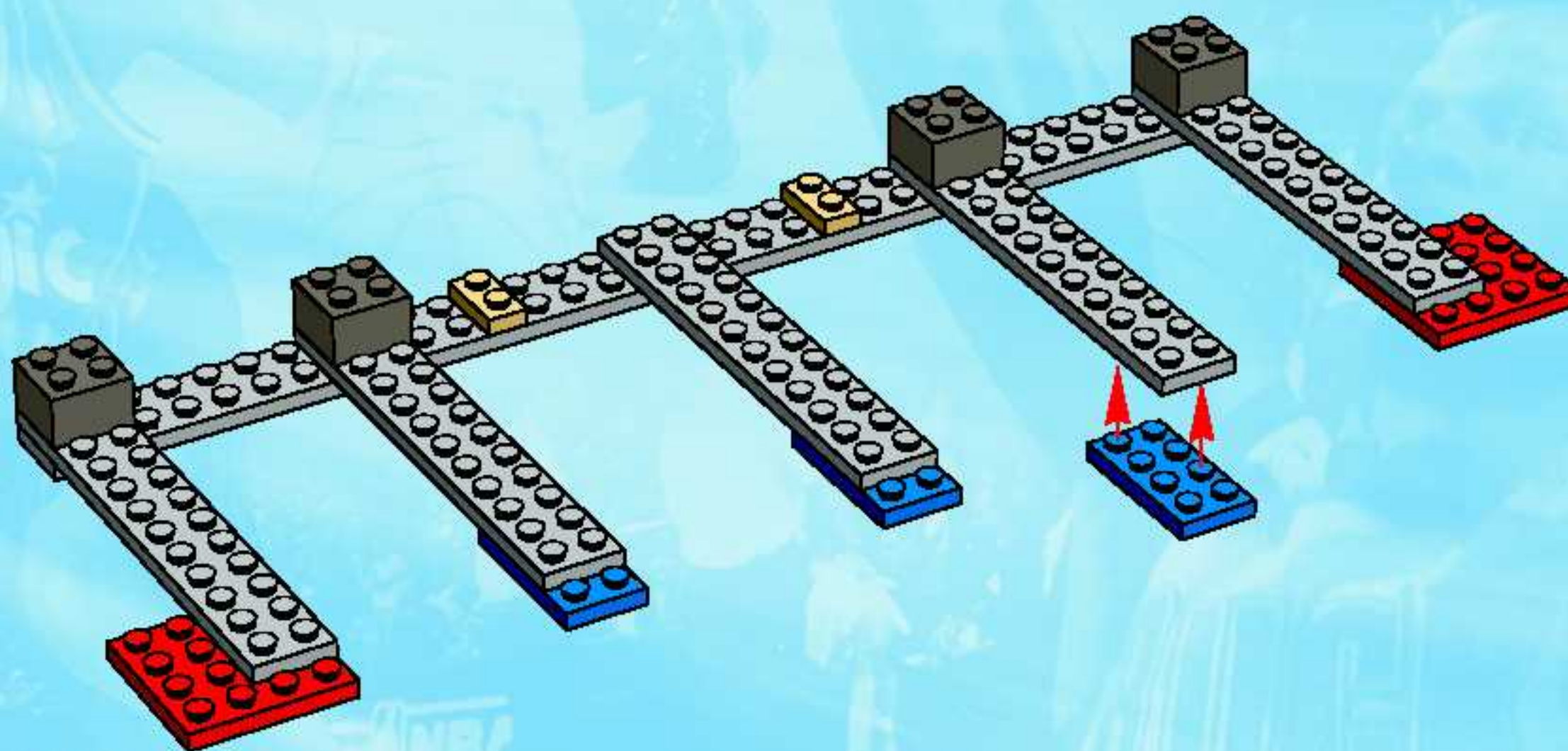

4

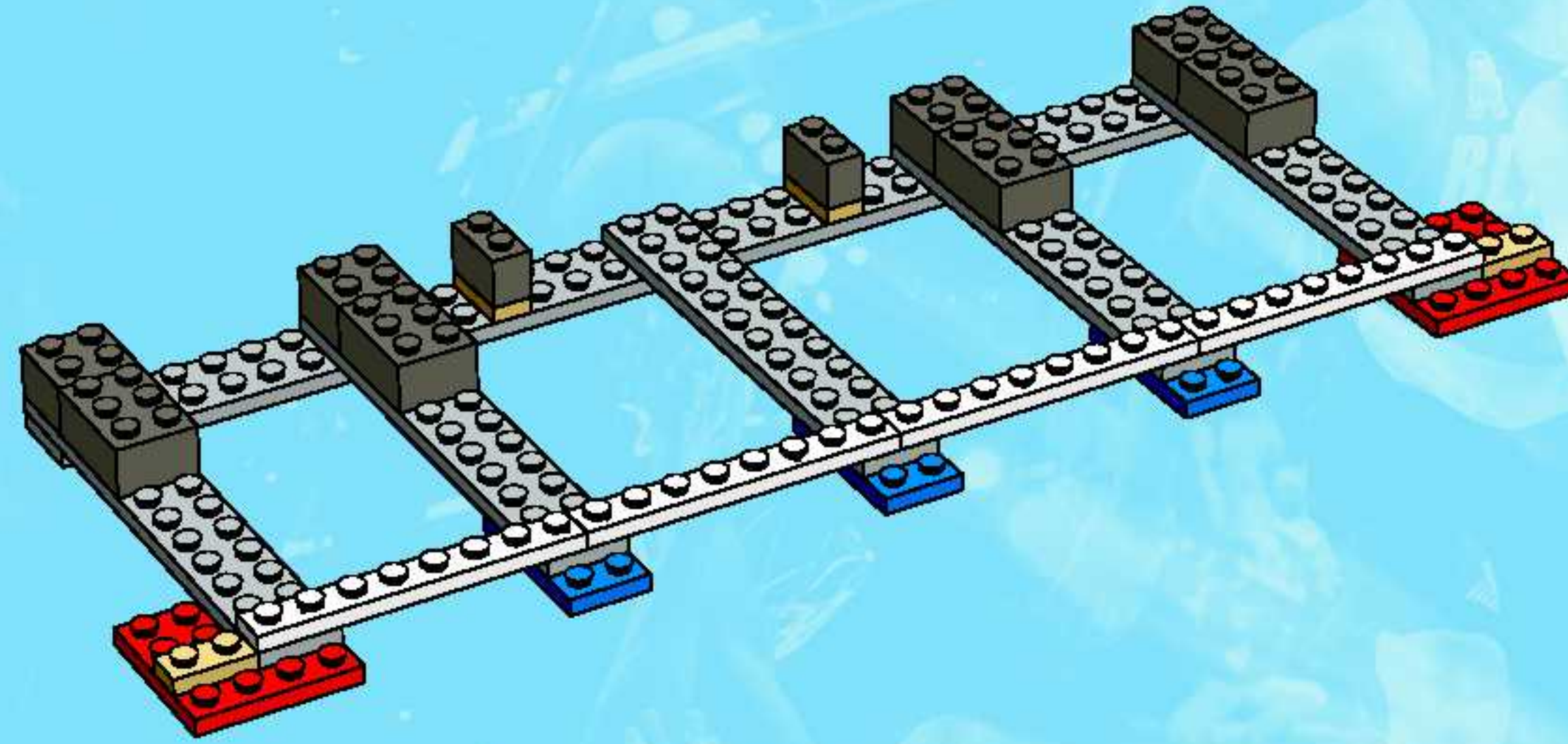

5

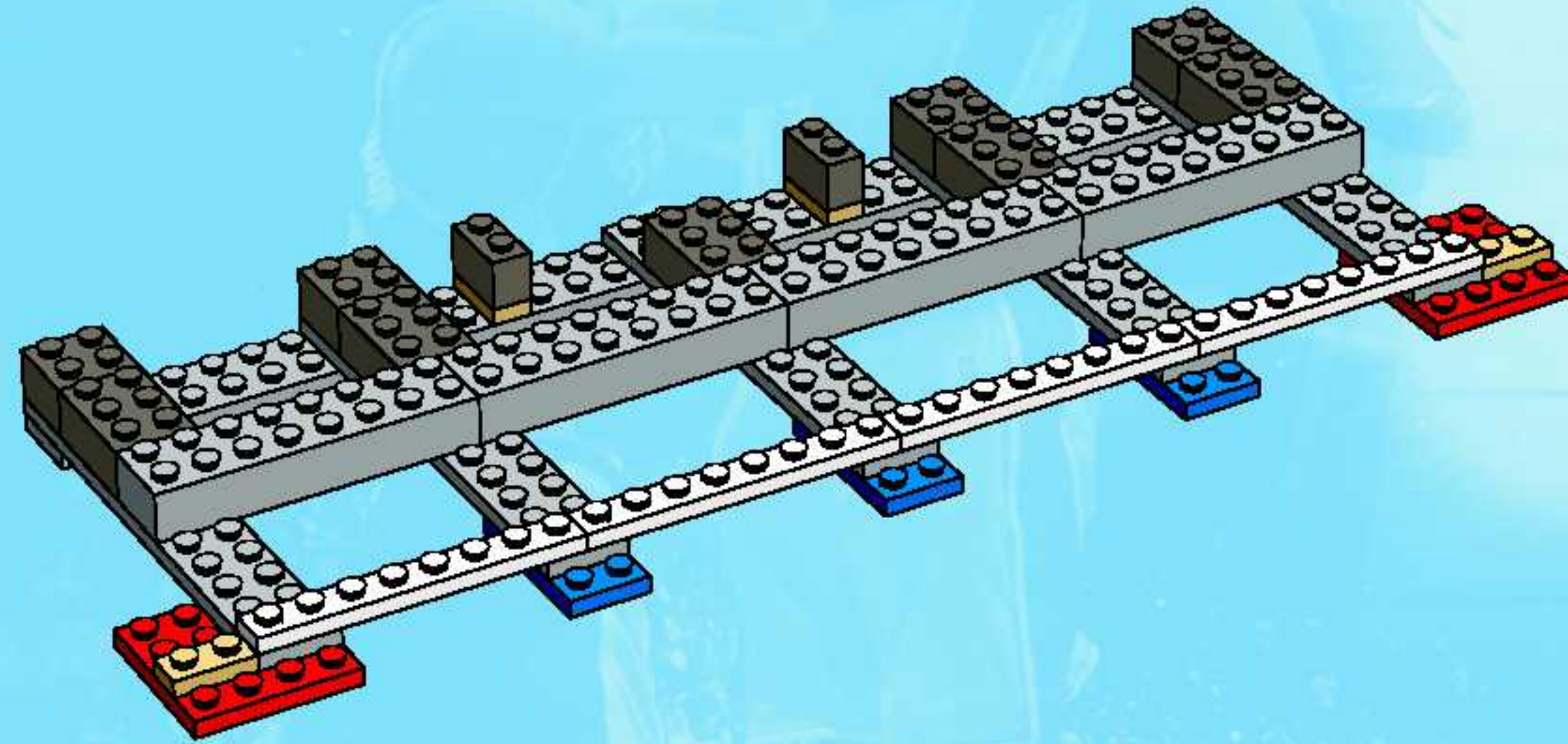

6

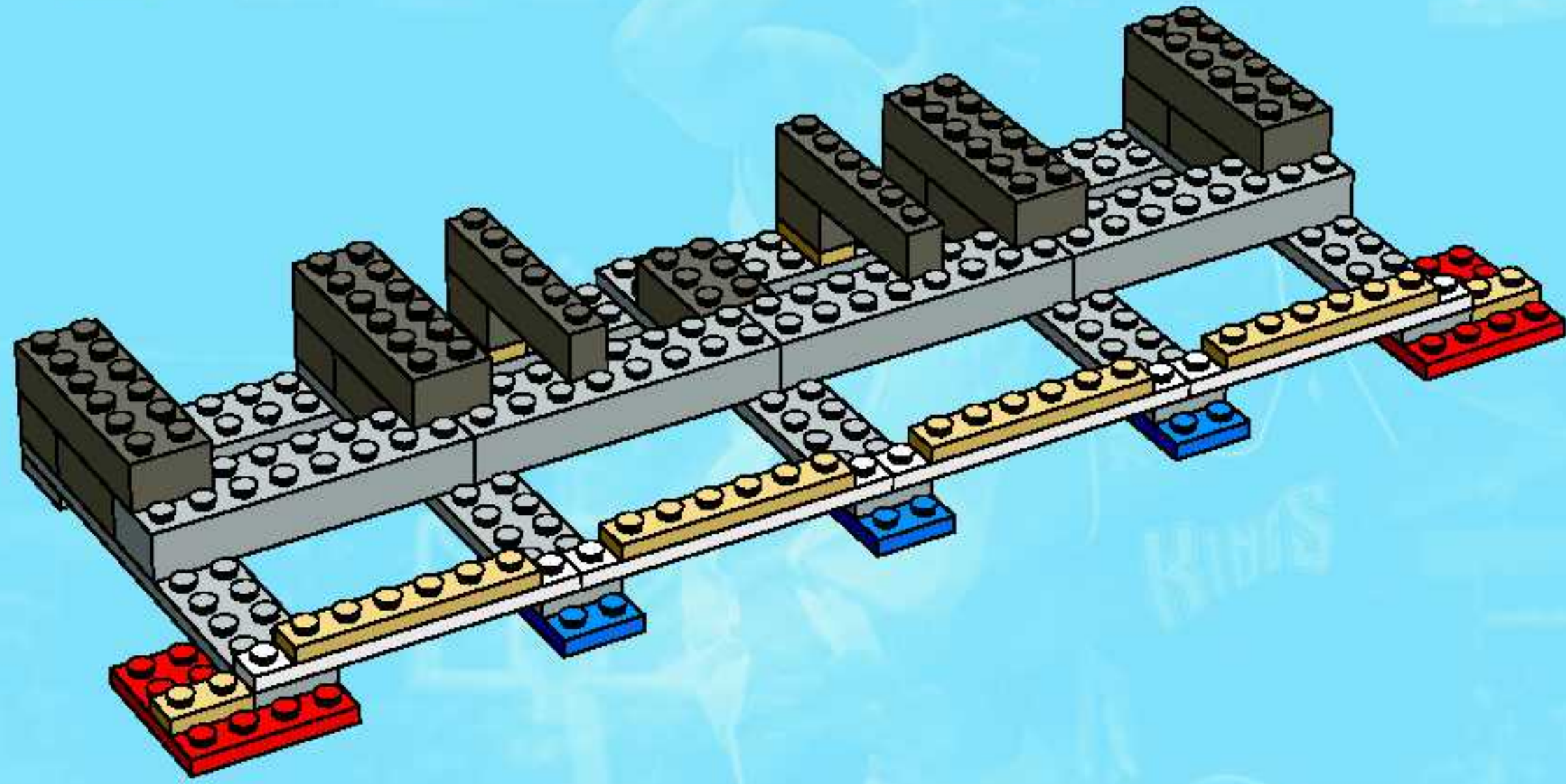

7

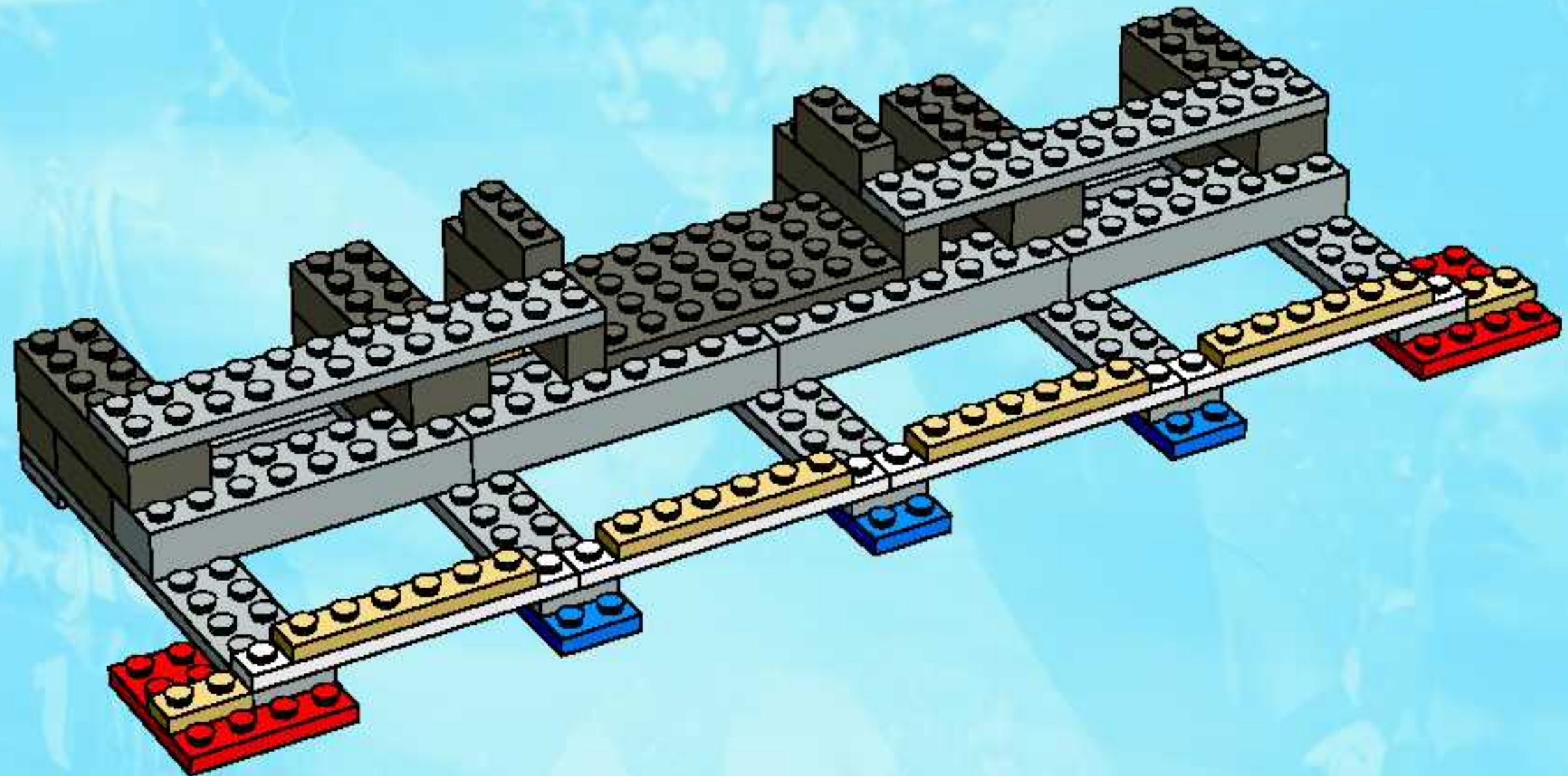

8

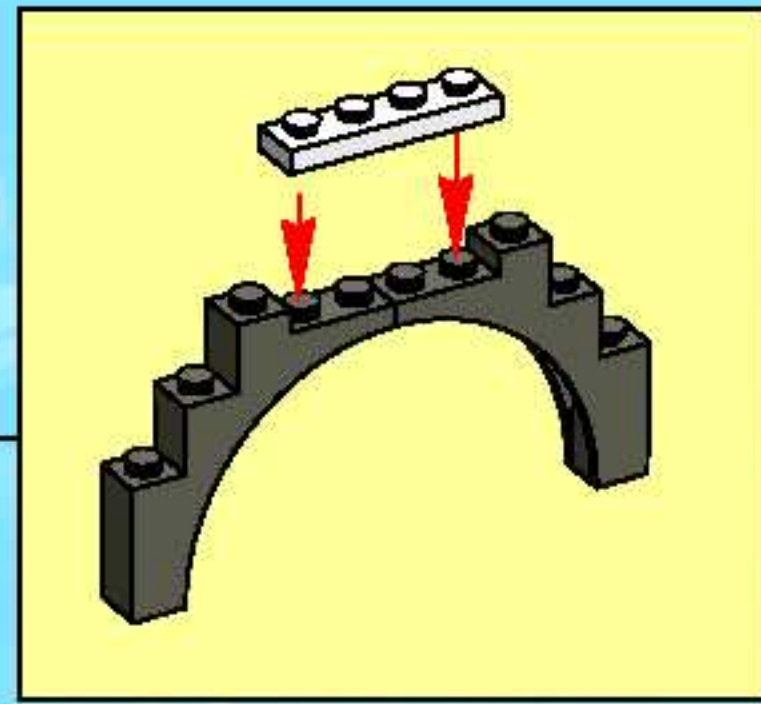
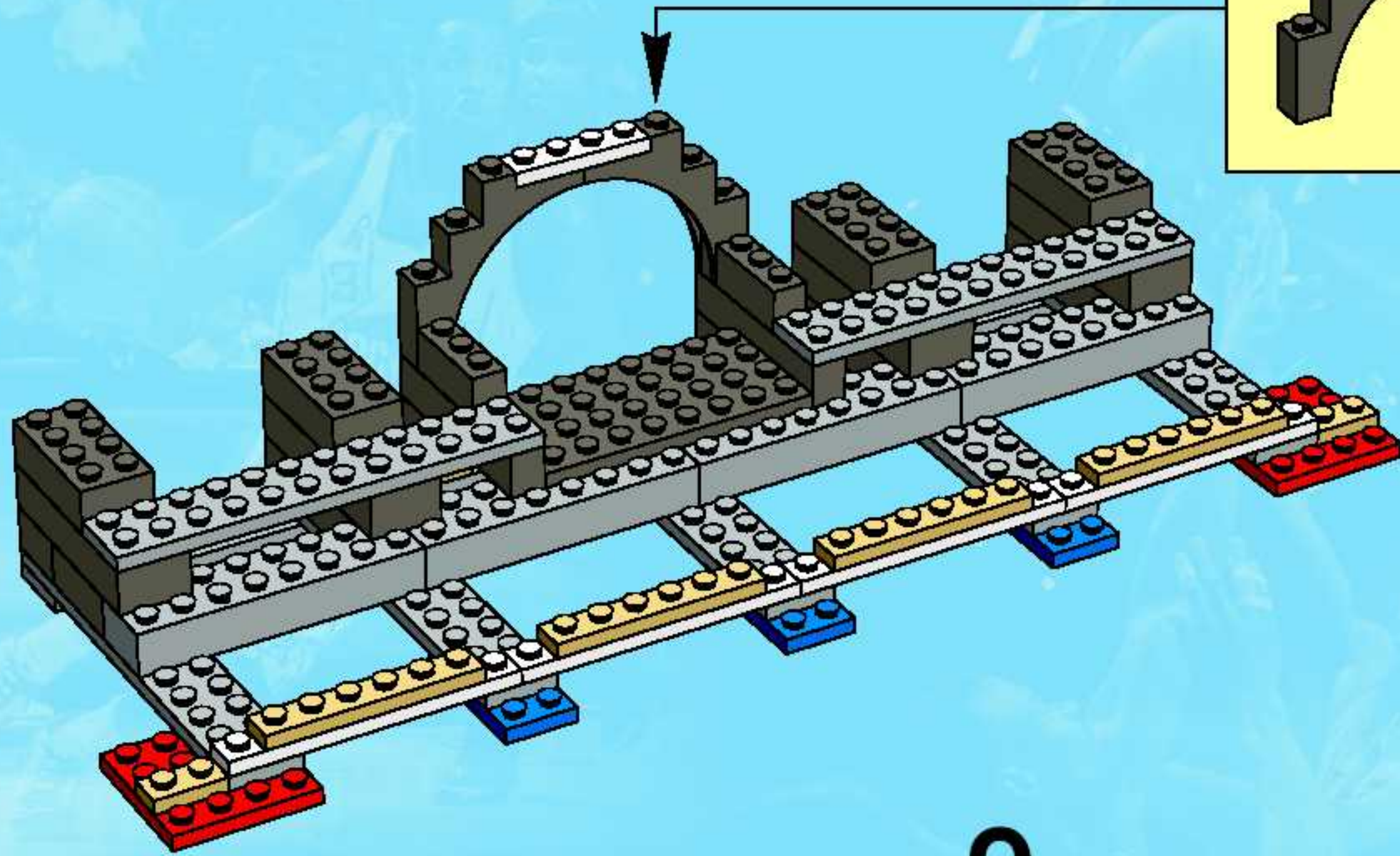

9

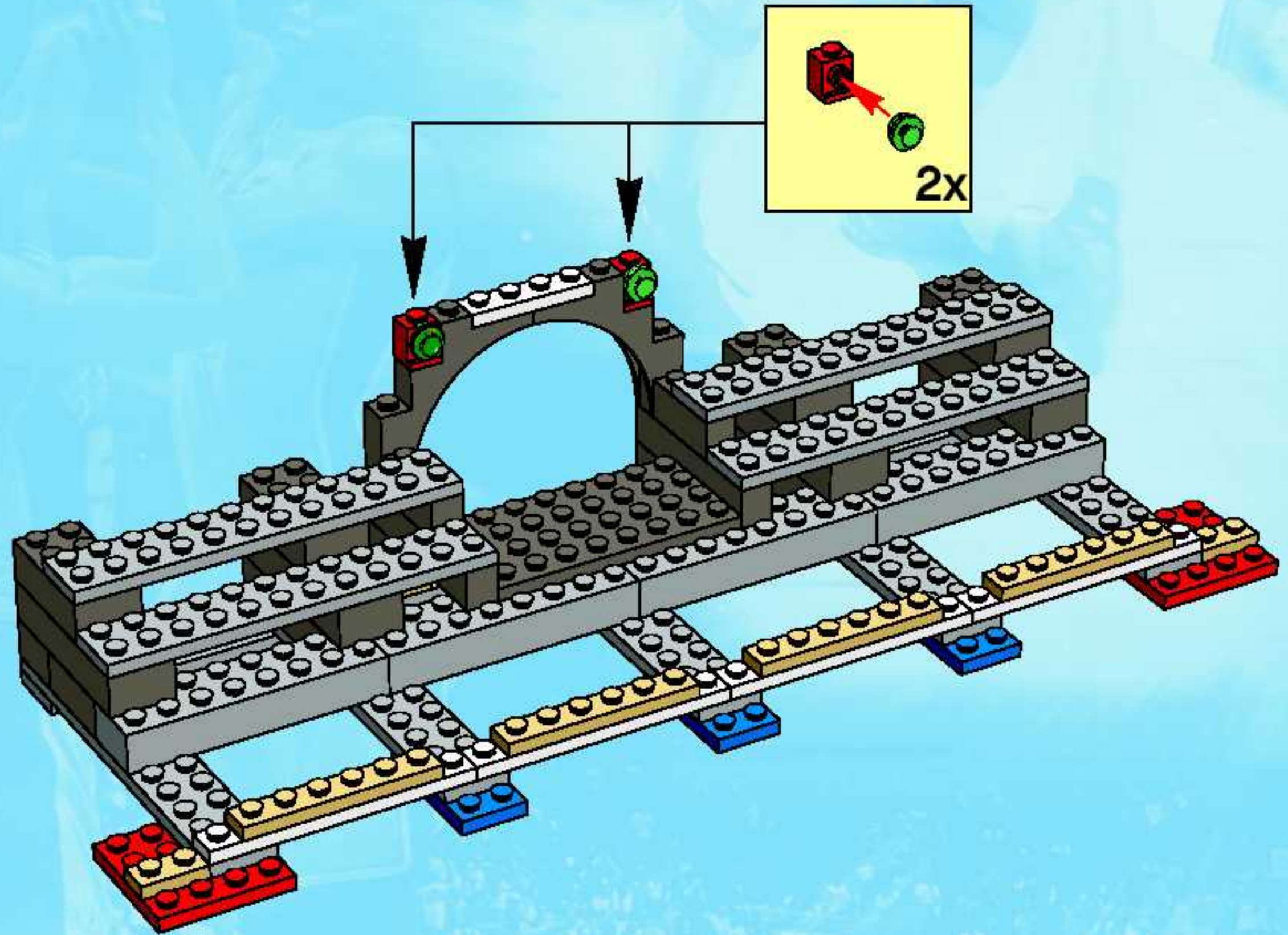

10

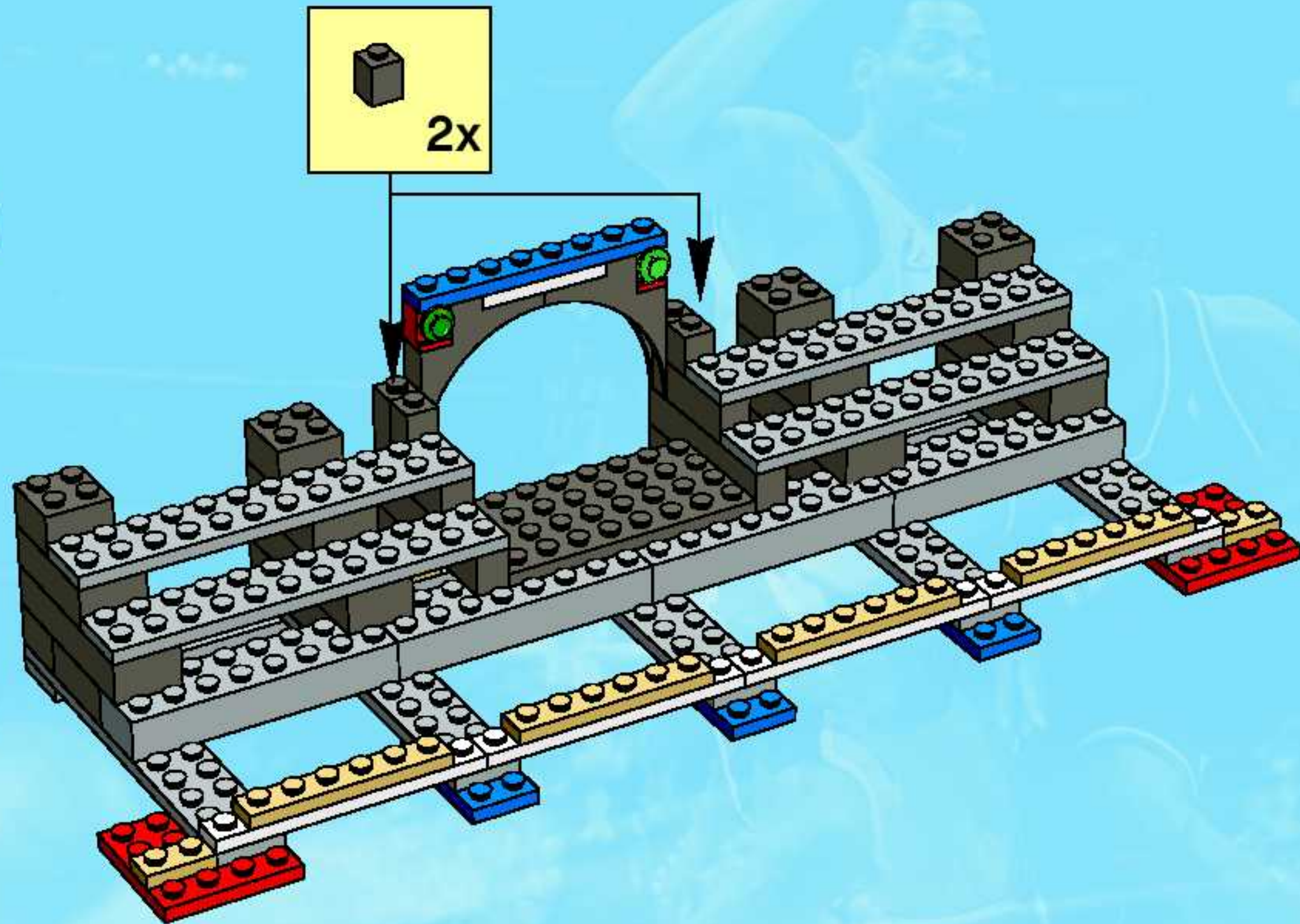

11

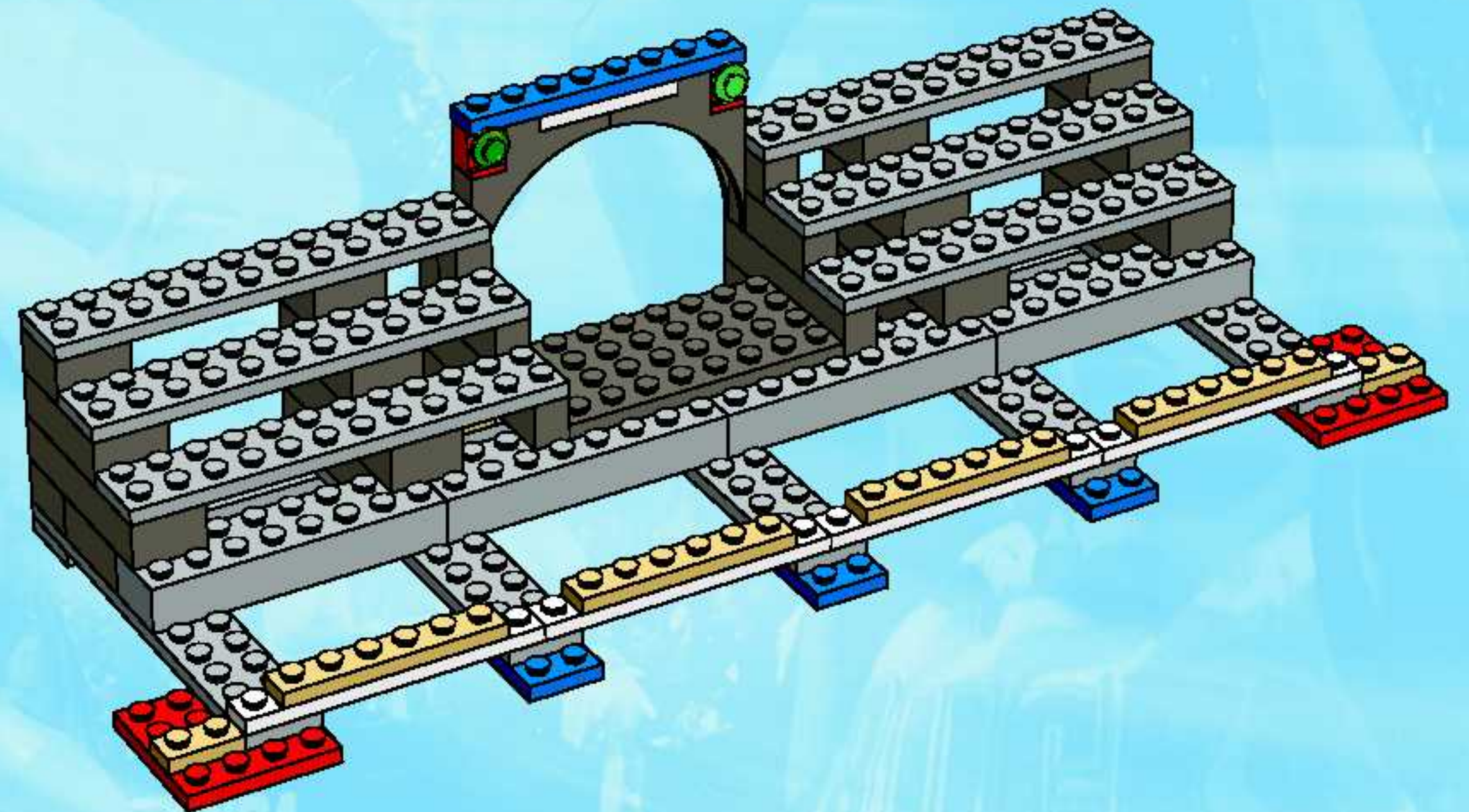

10

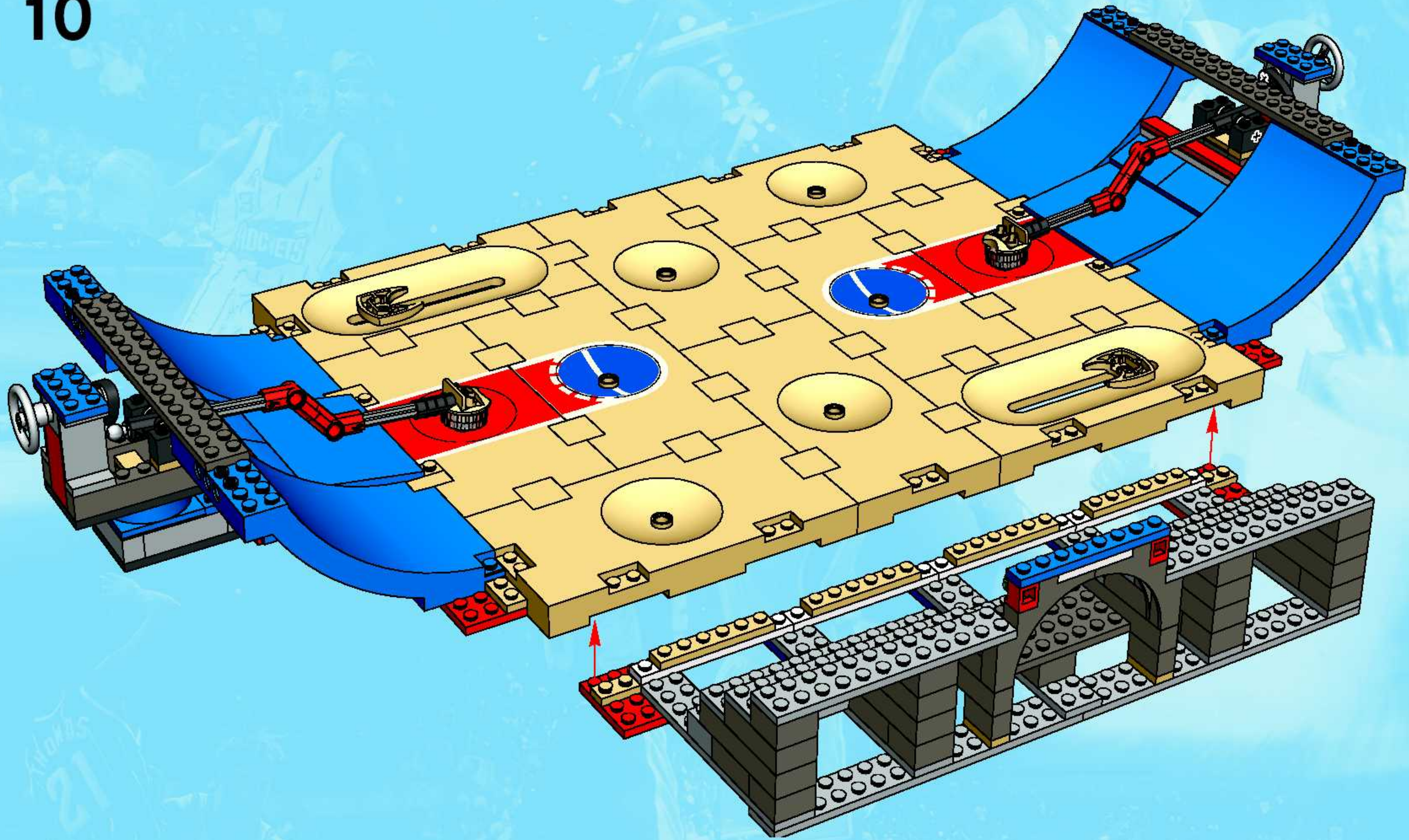

11

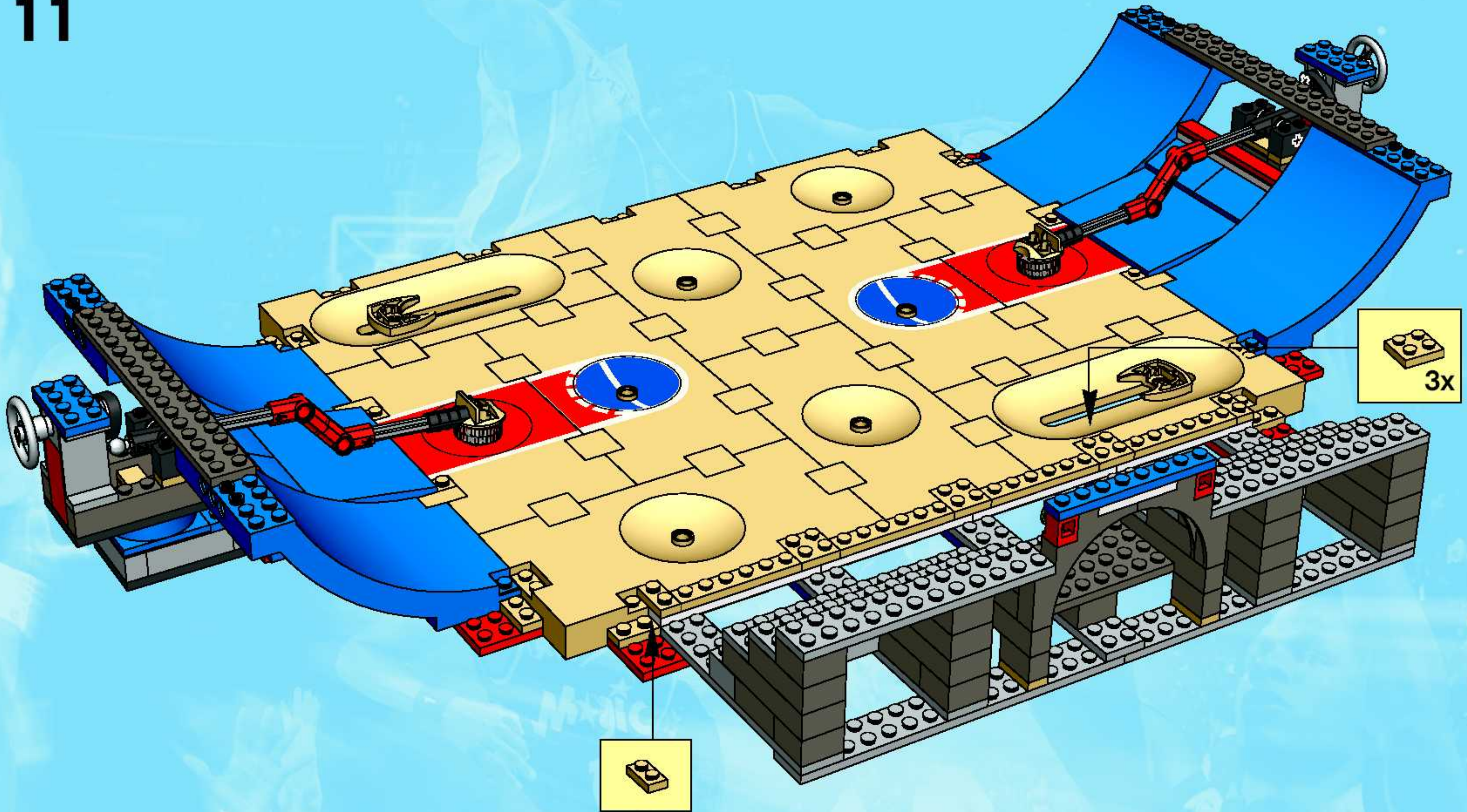

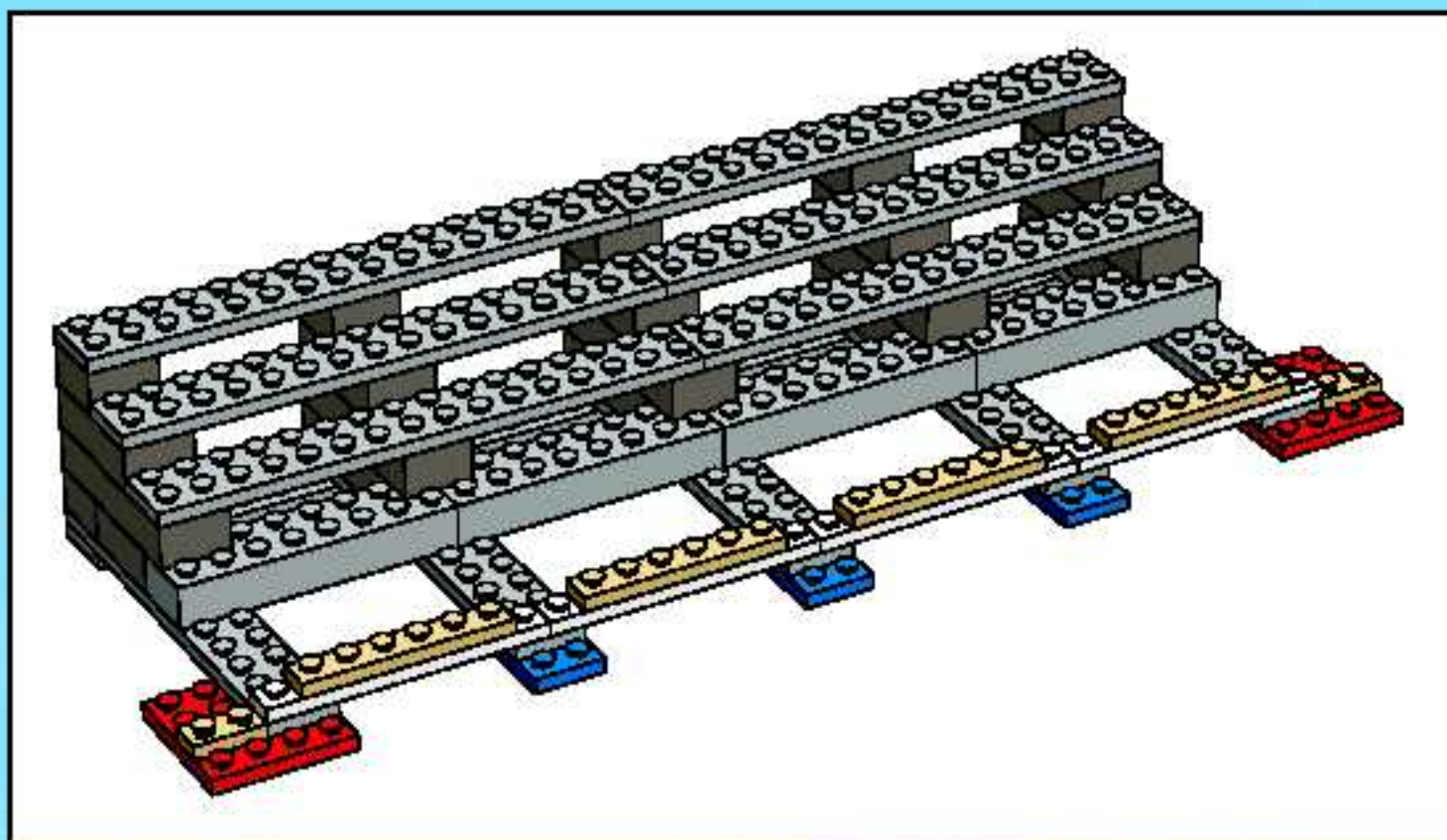

1

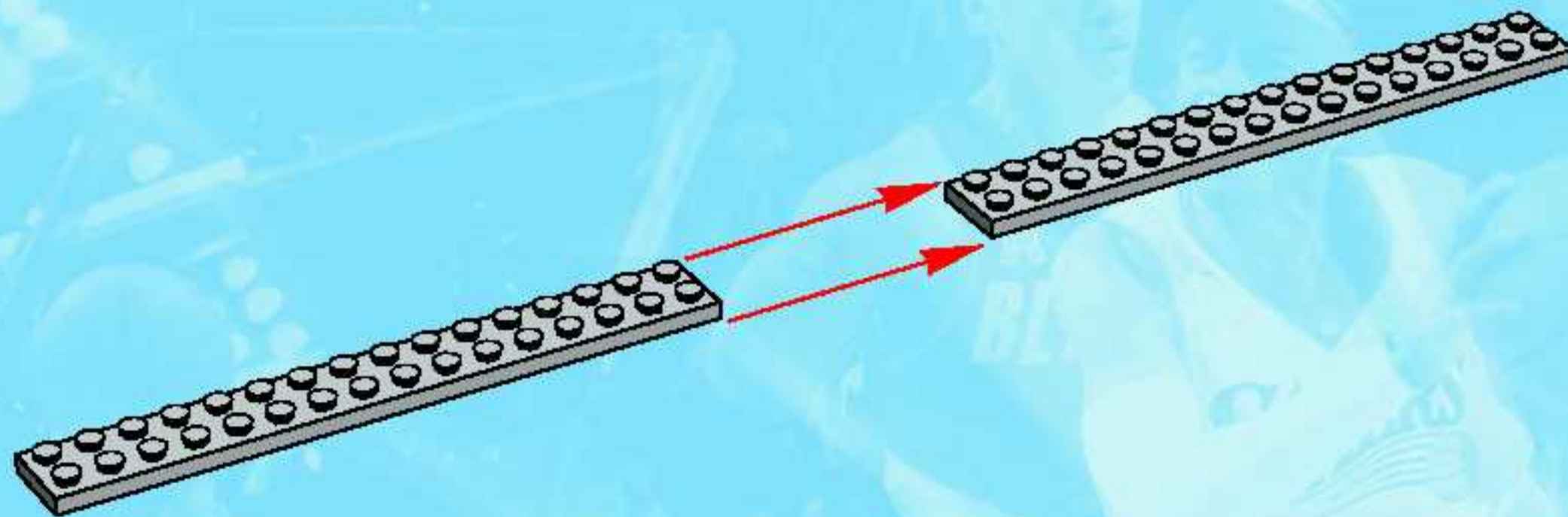

2

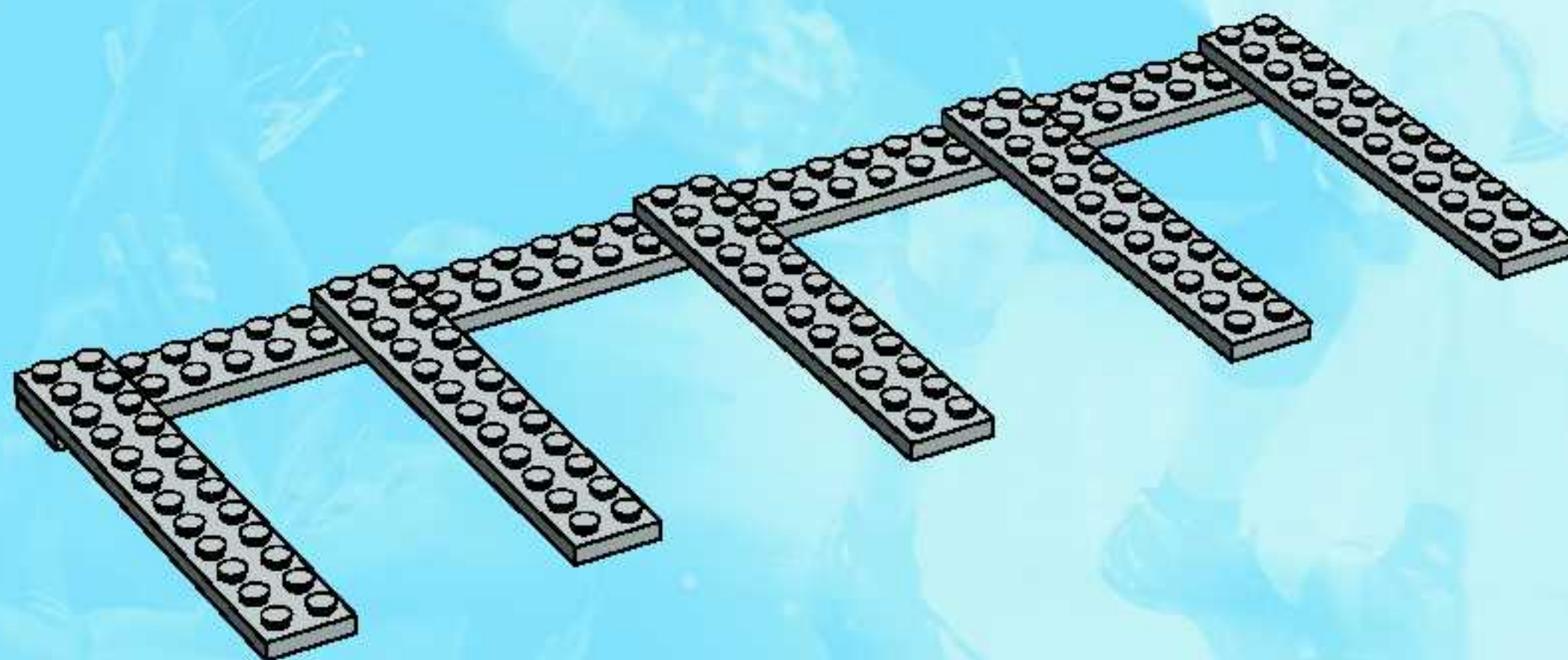

3

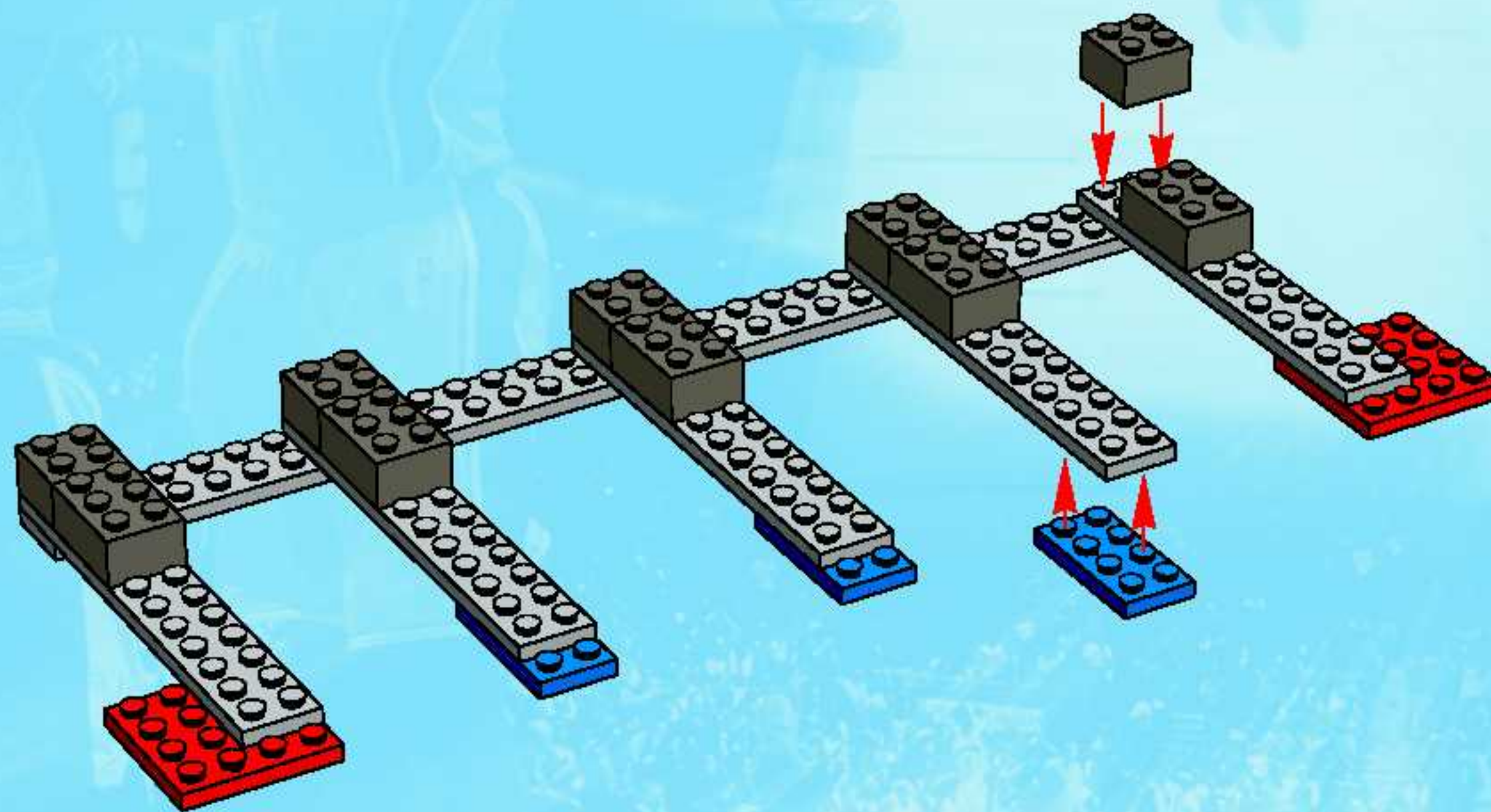

4

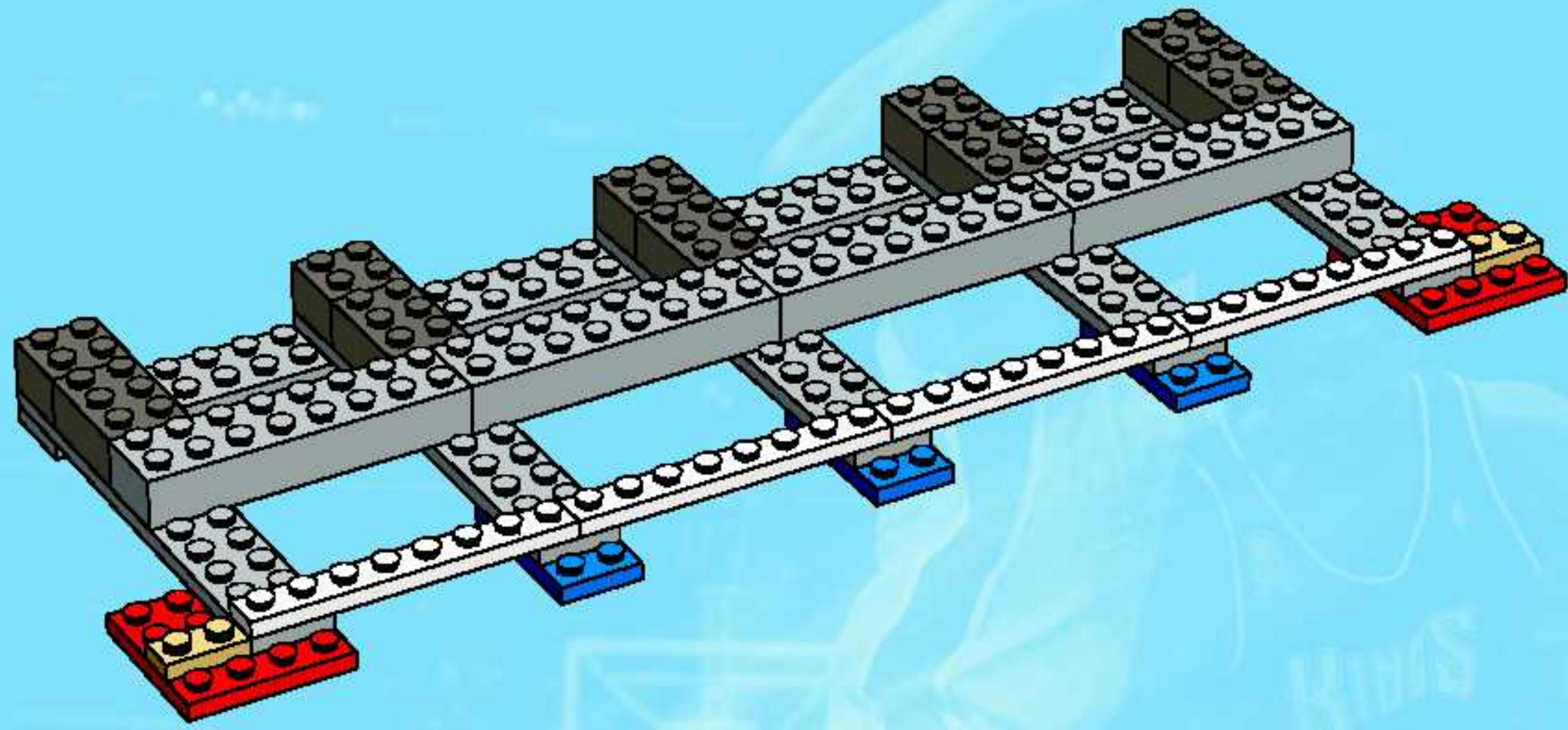

5

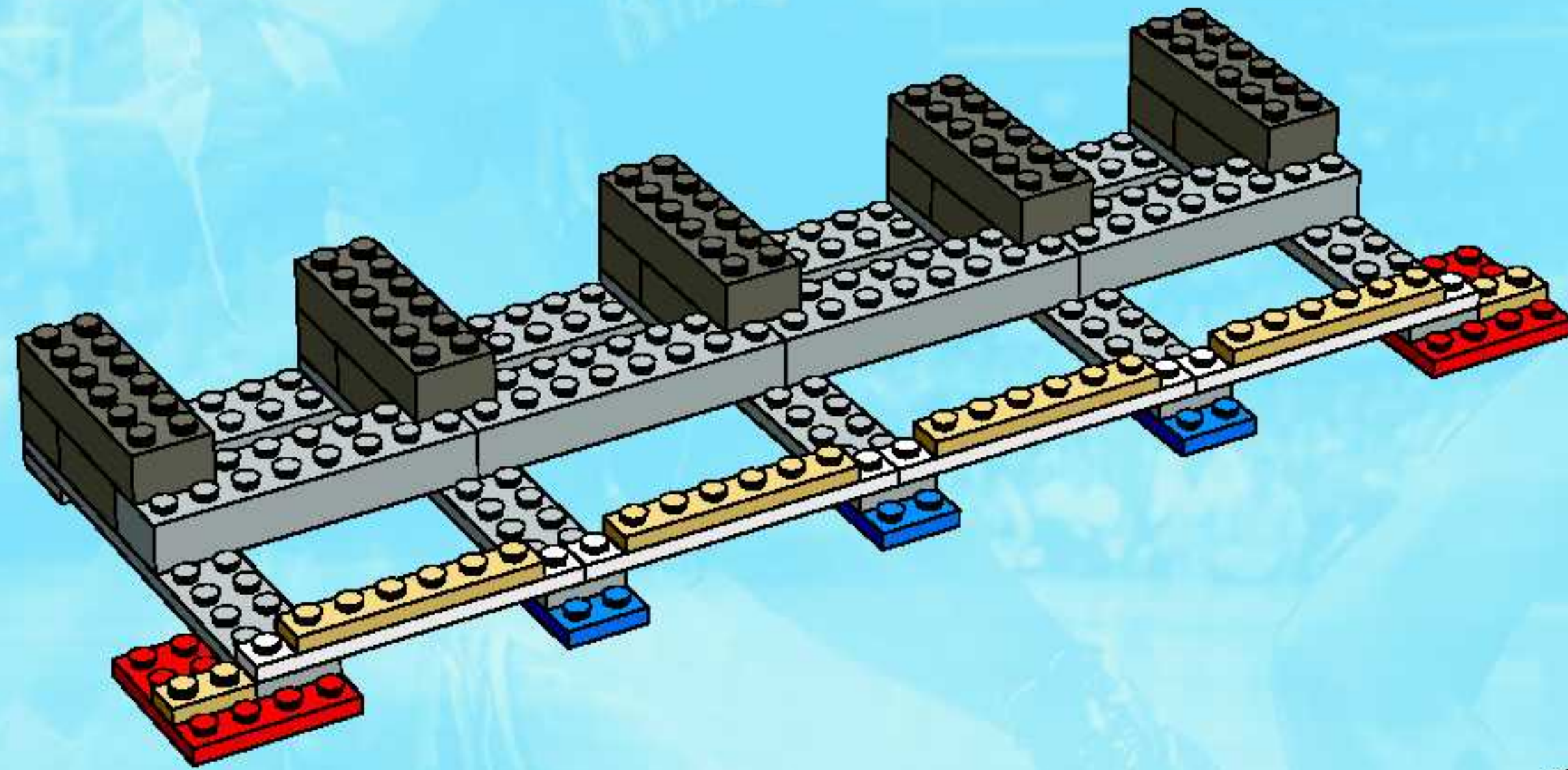

6

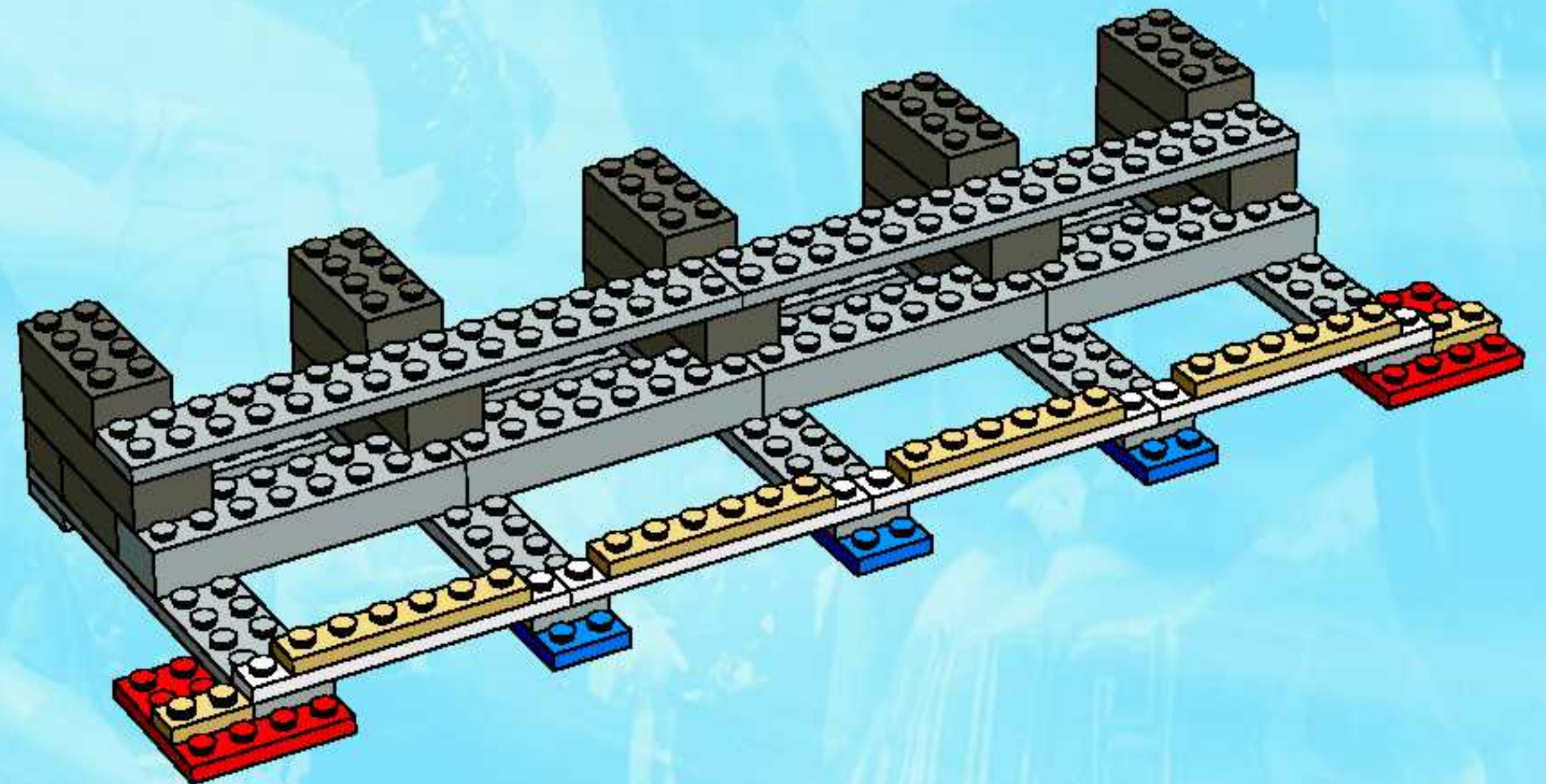

7

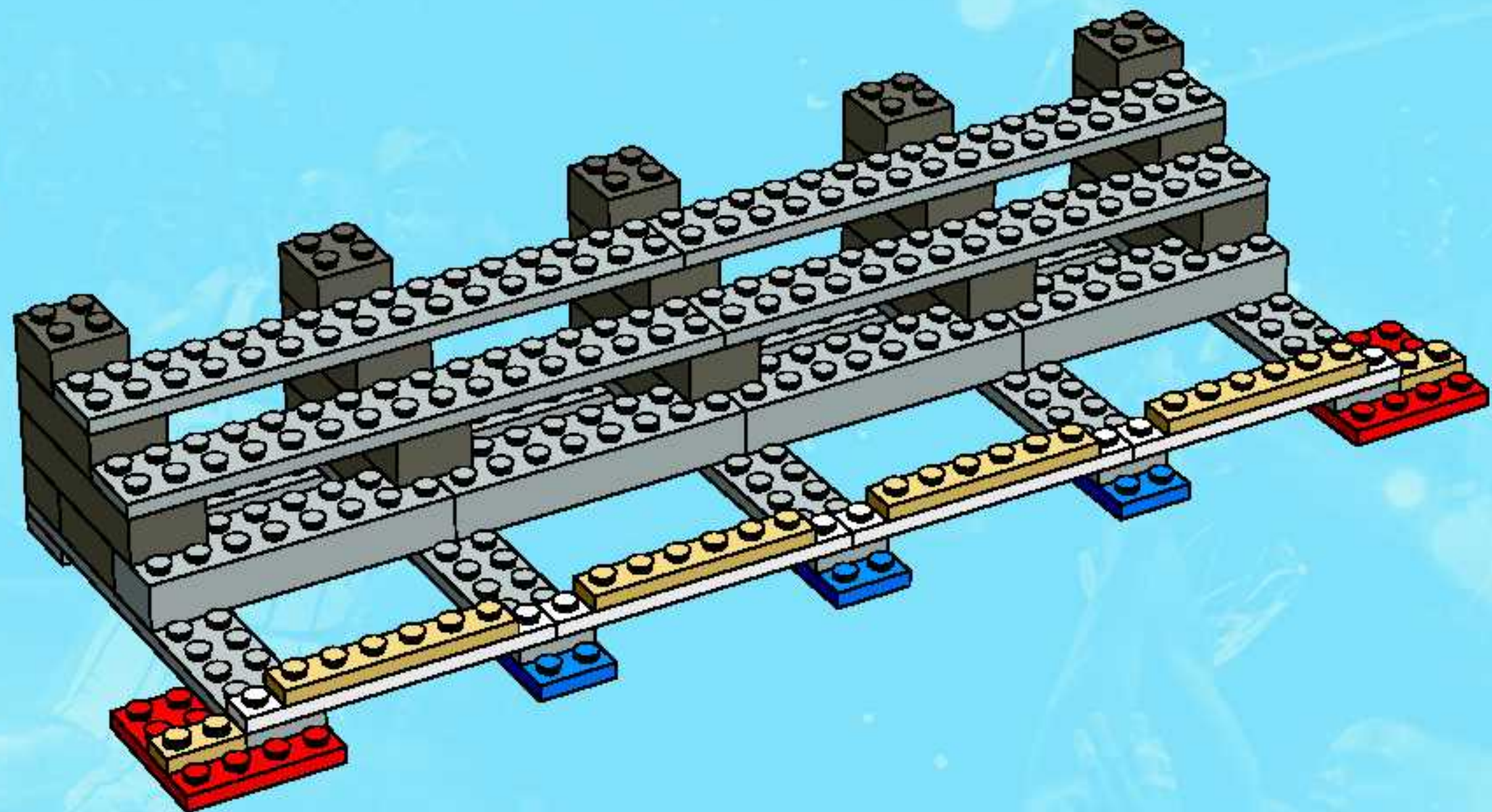

8

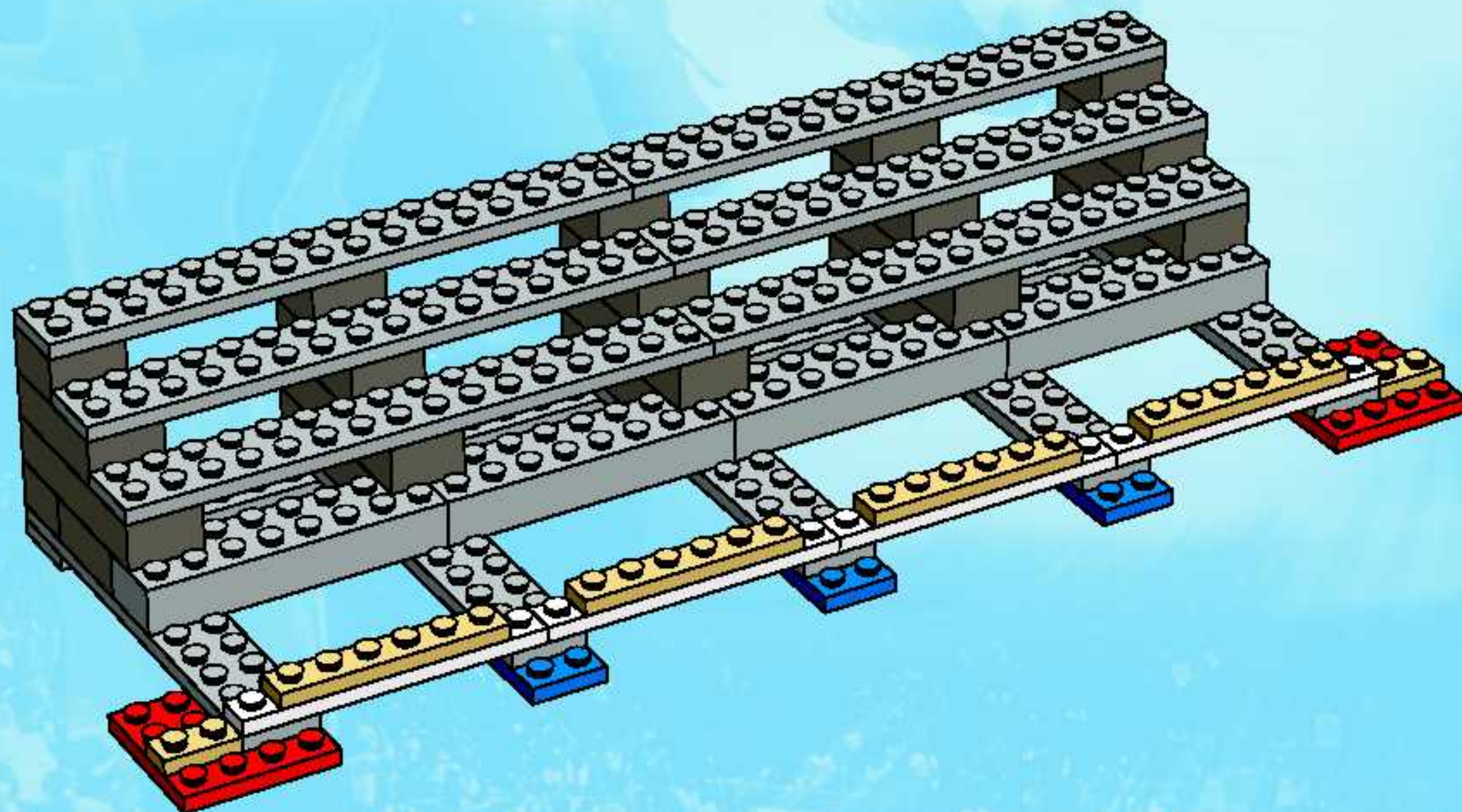

12

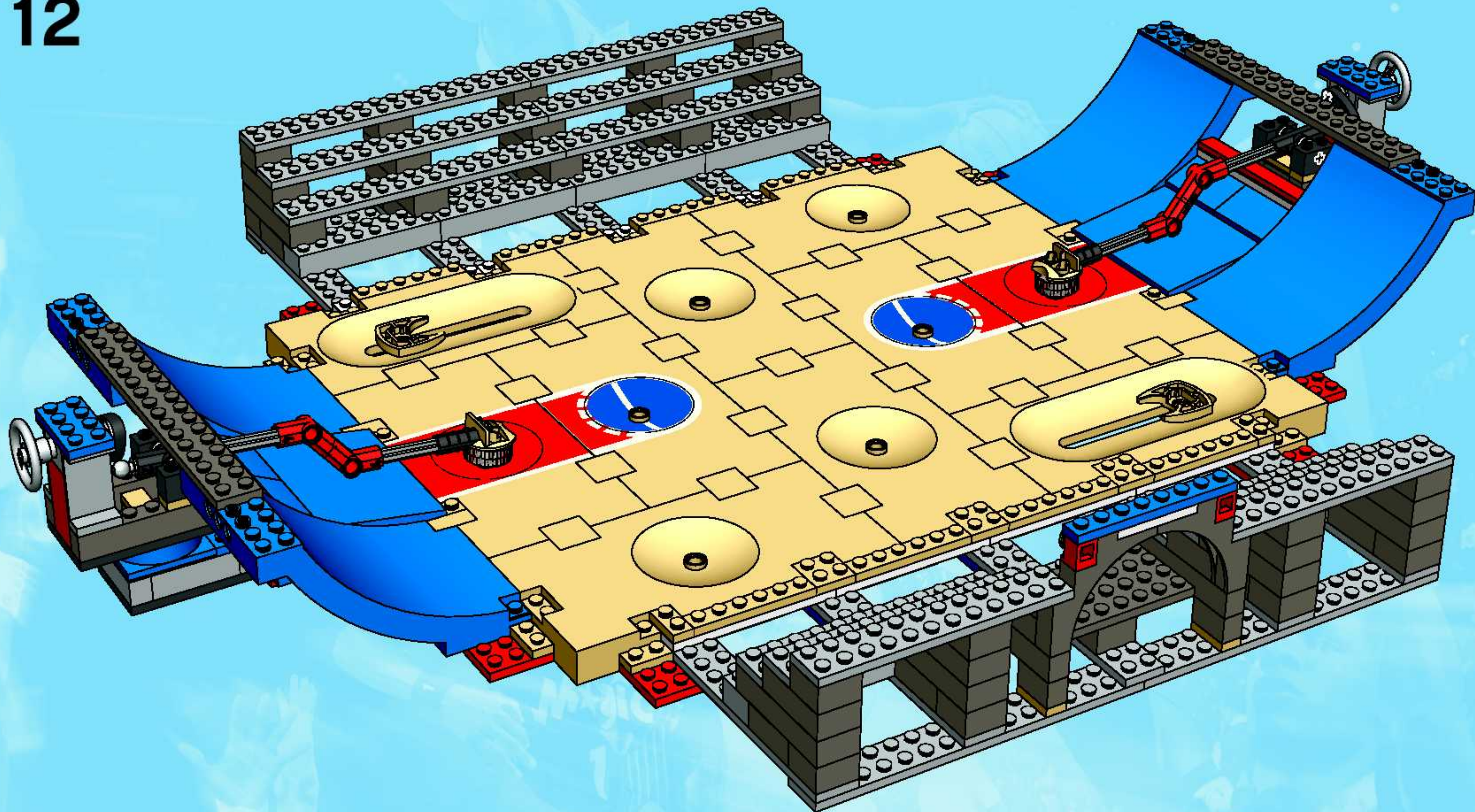

13

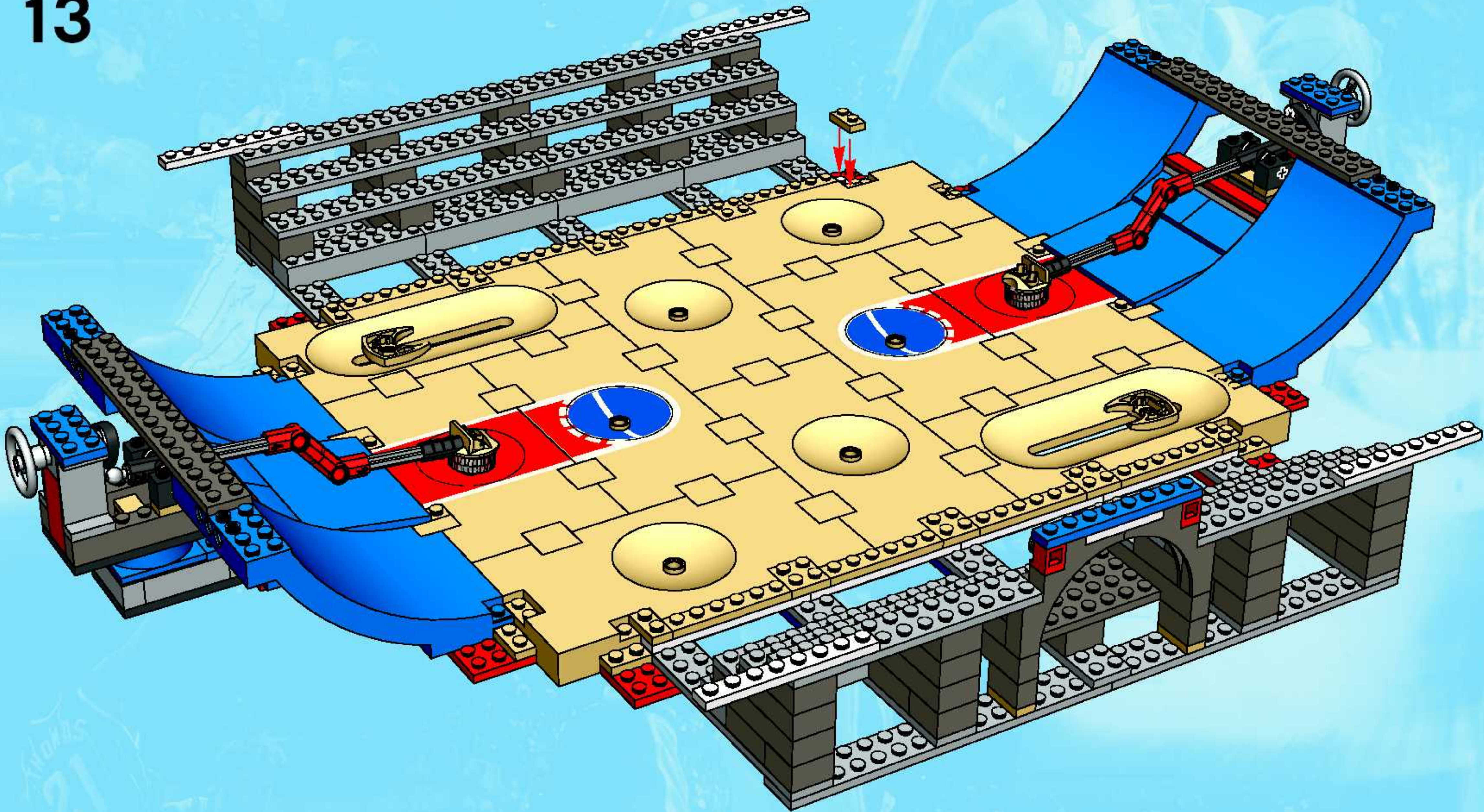

14

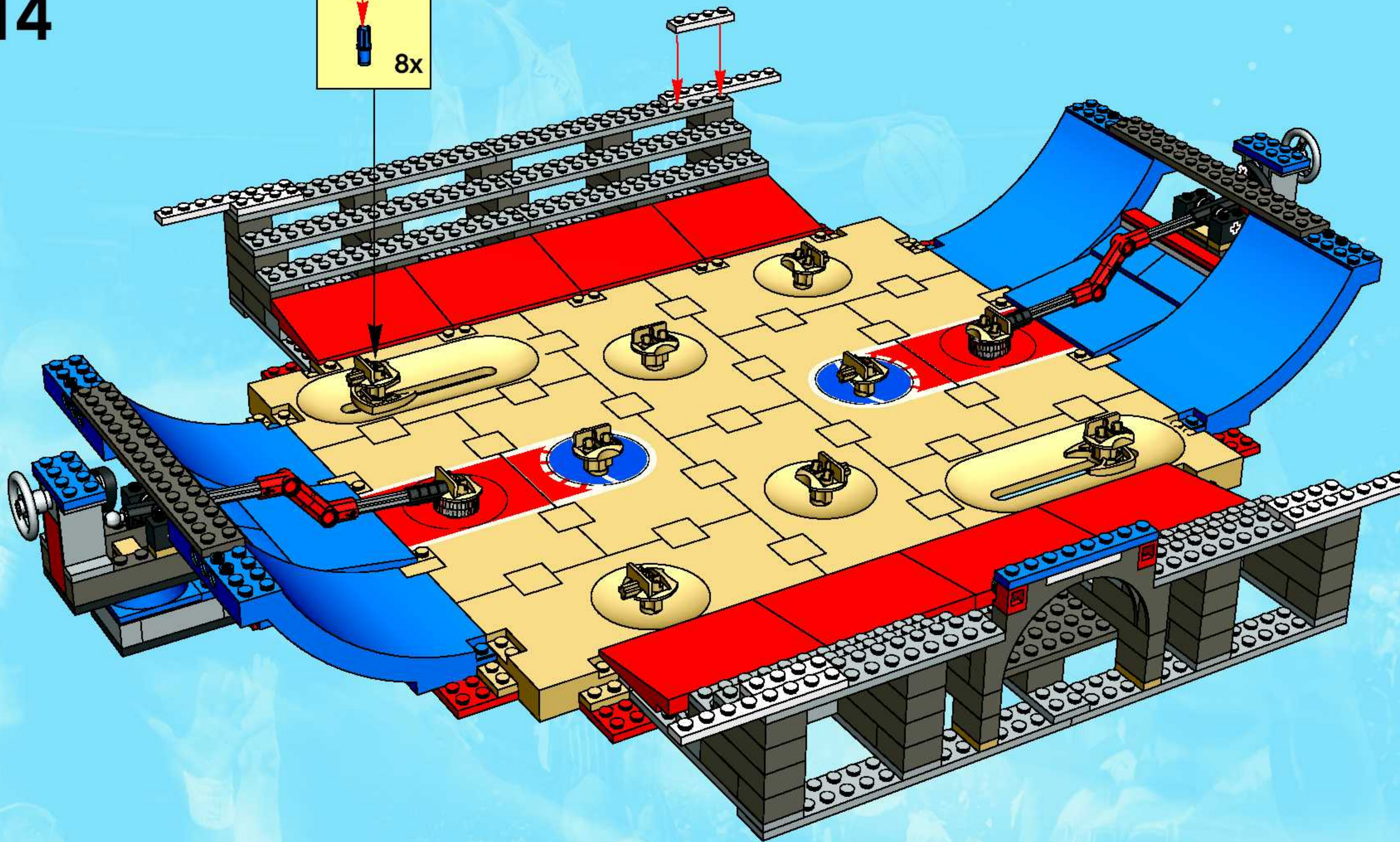
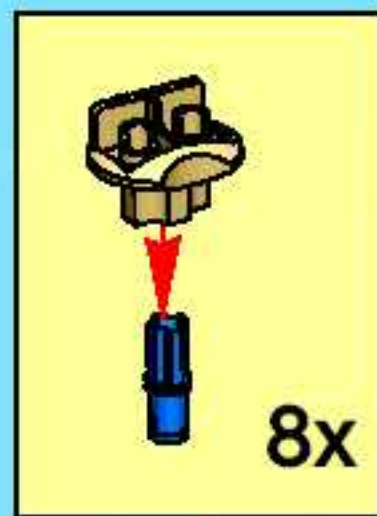

15

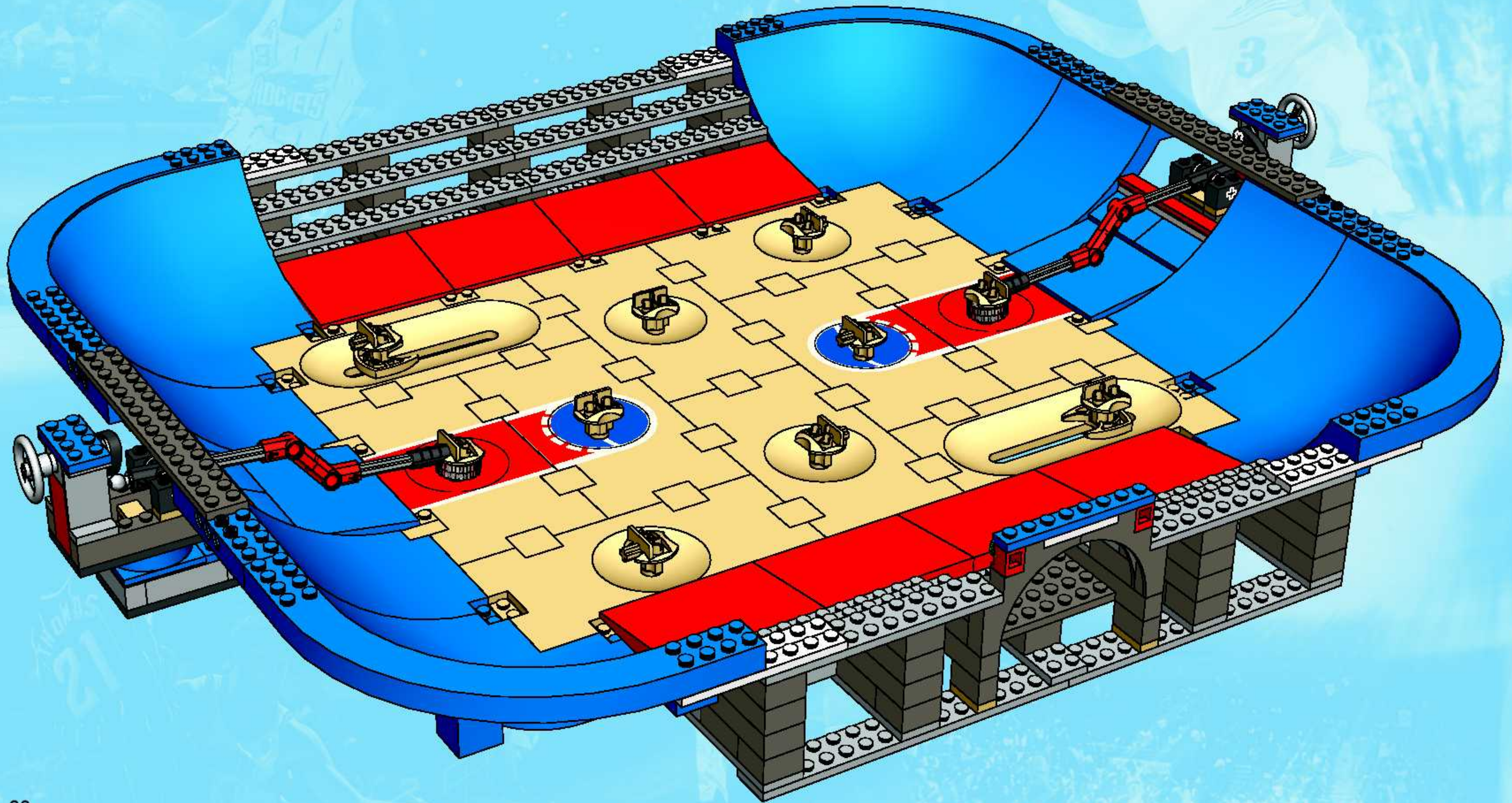

16

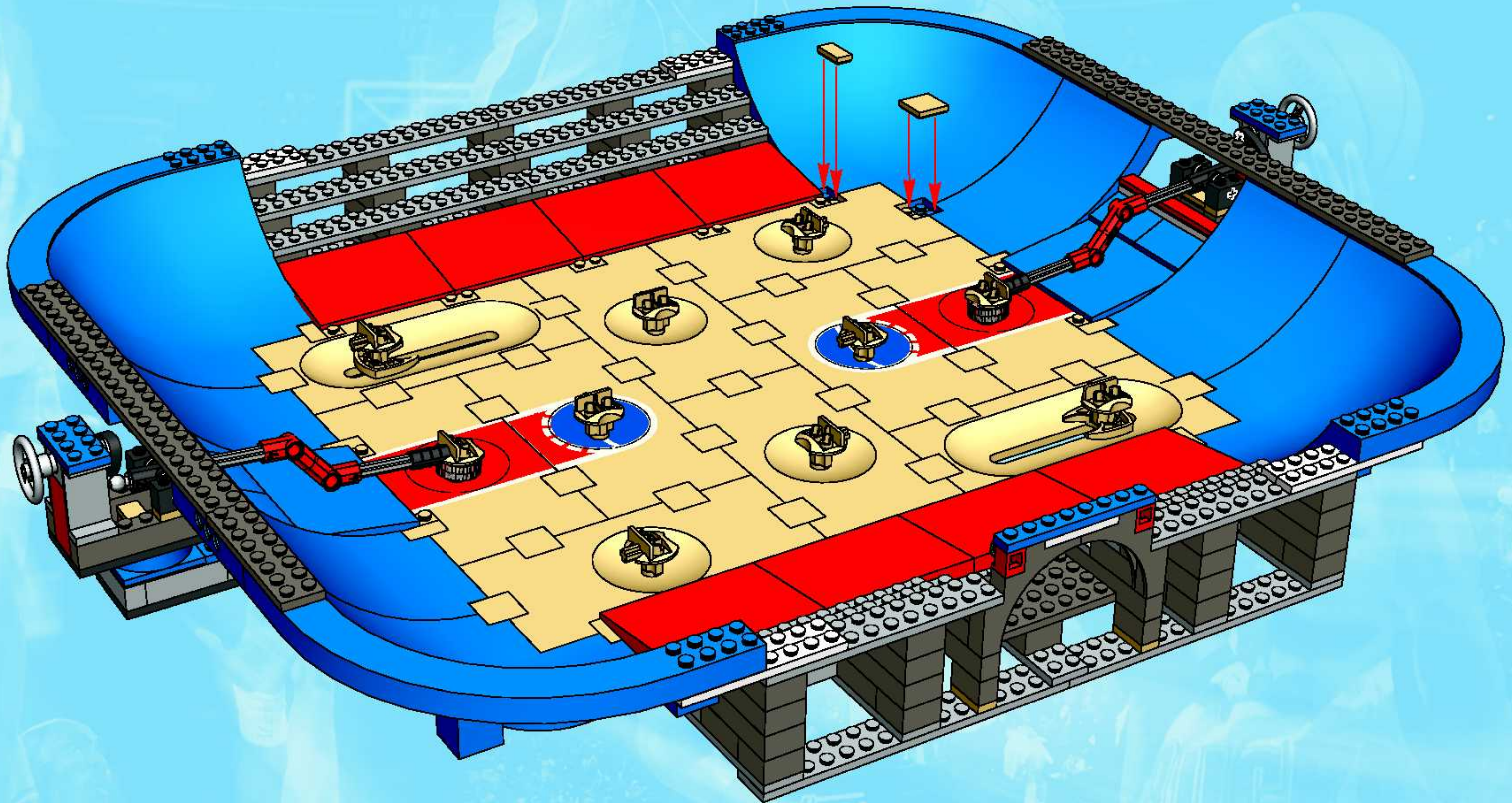

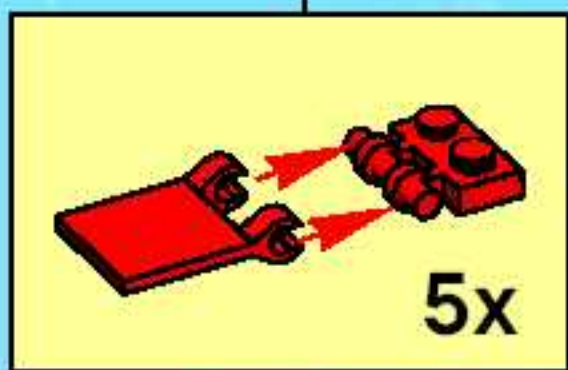
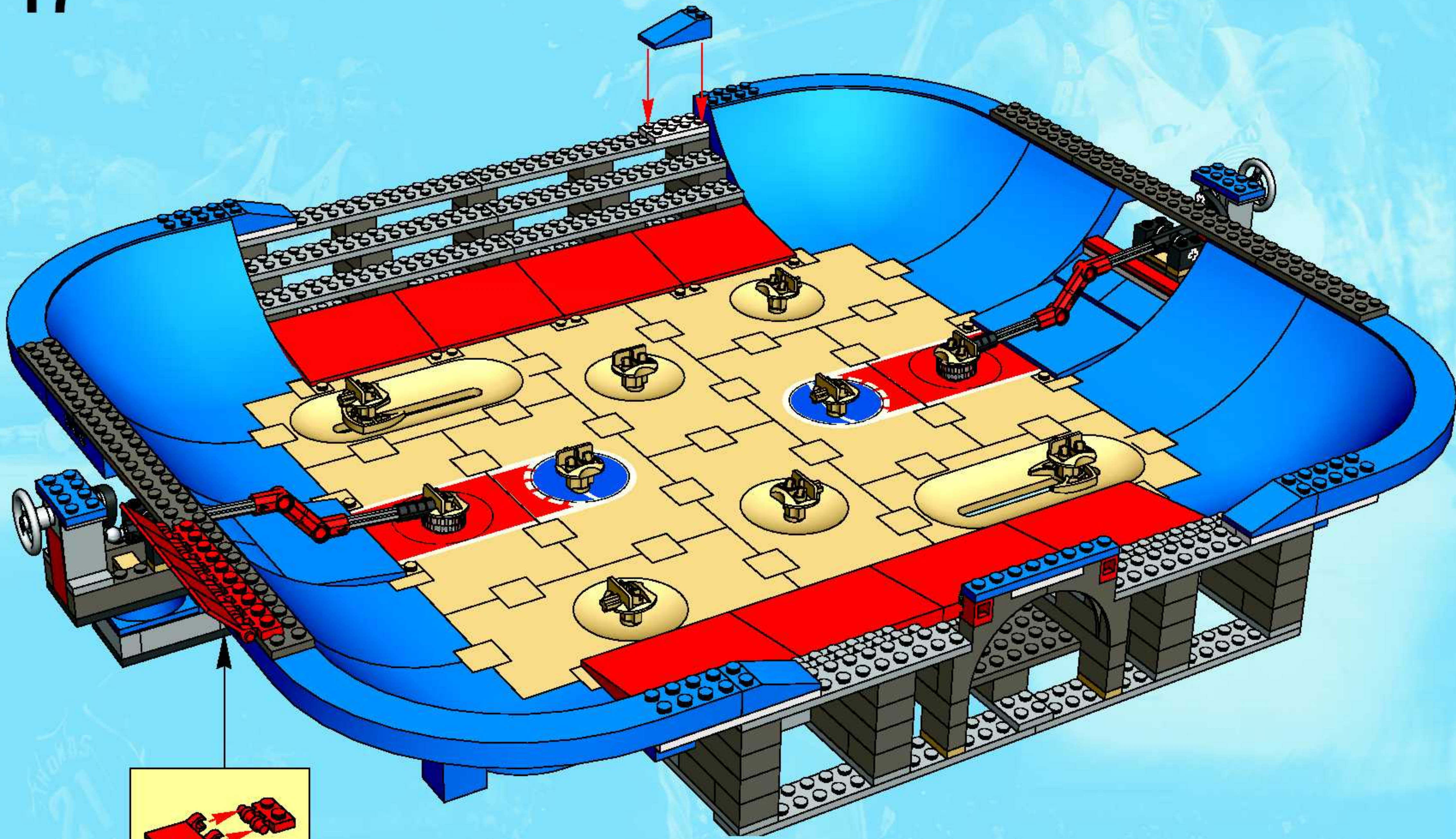

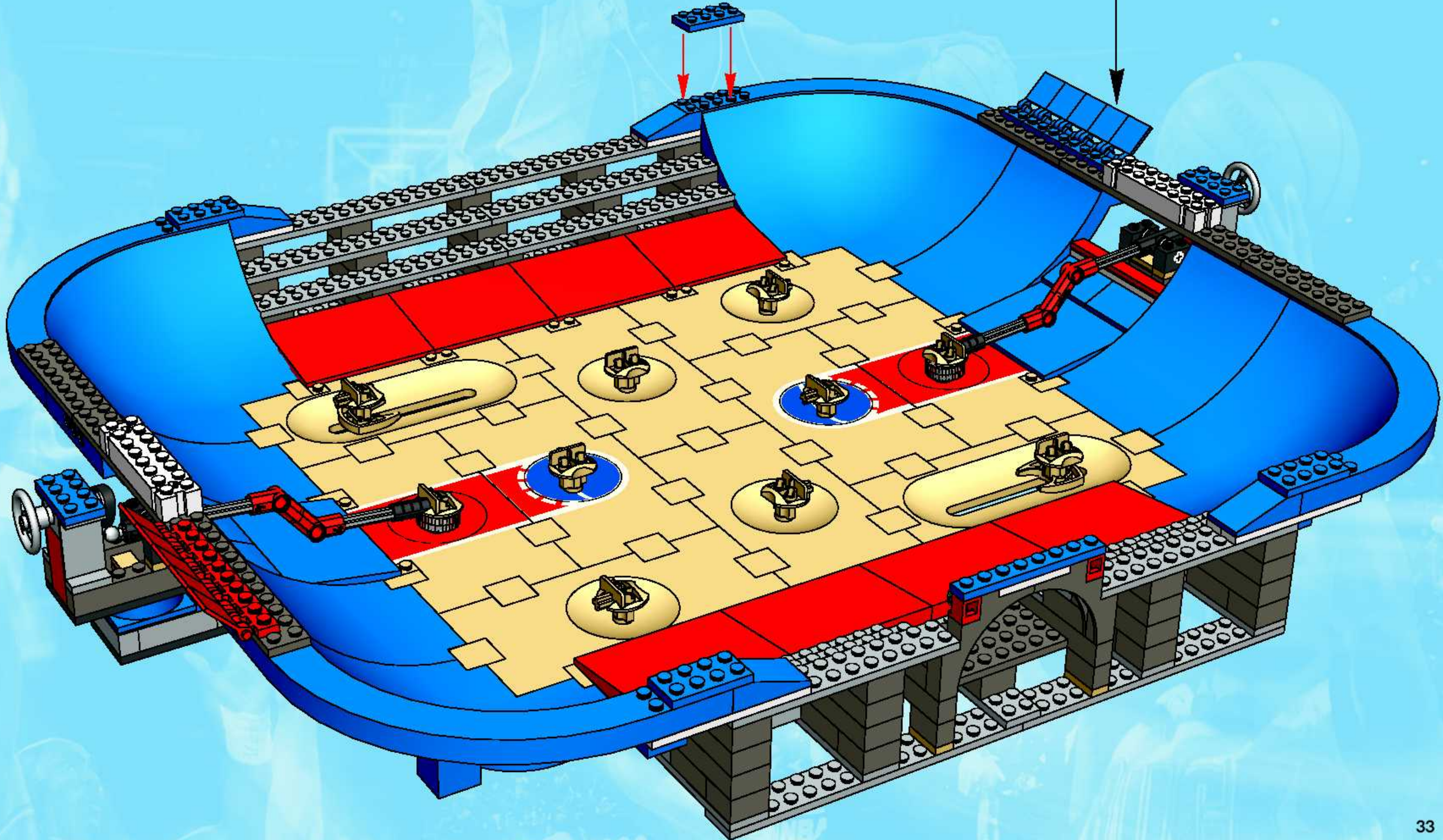
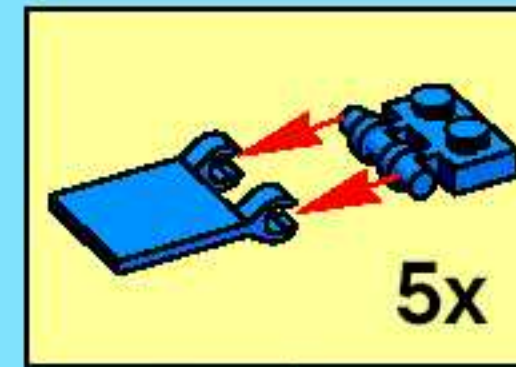

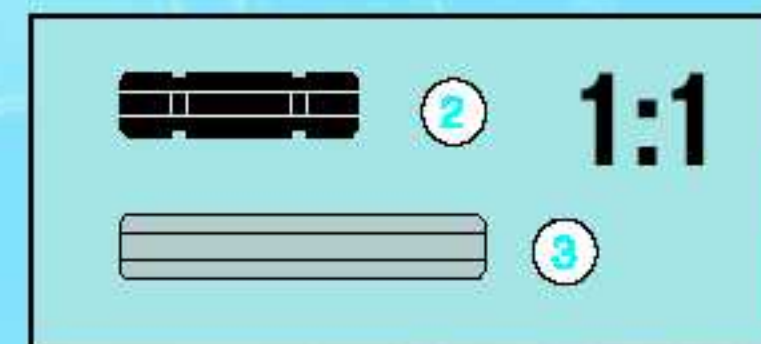
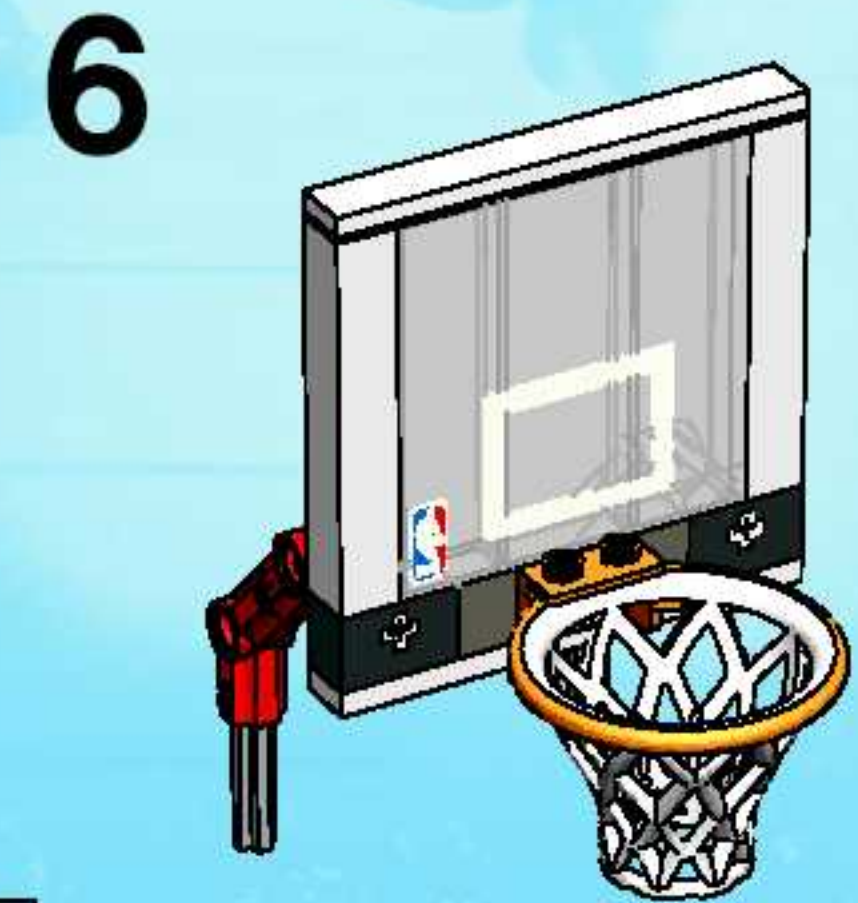
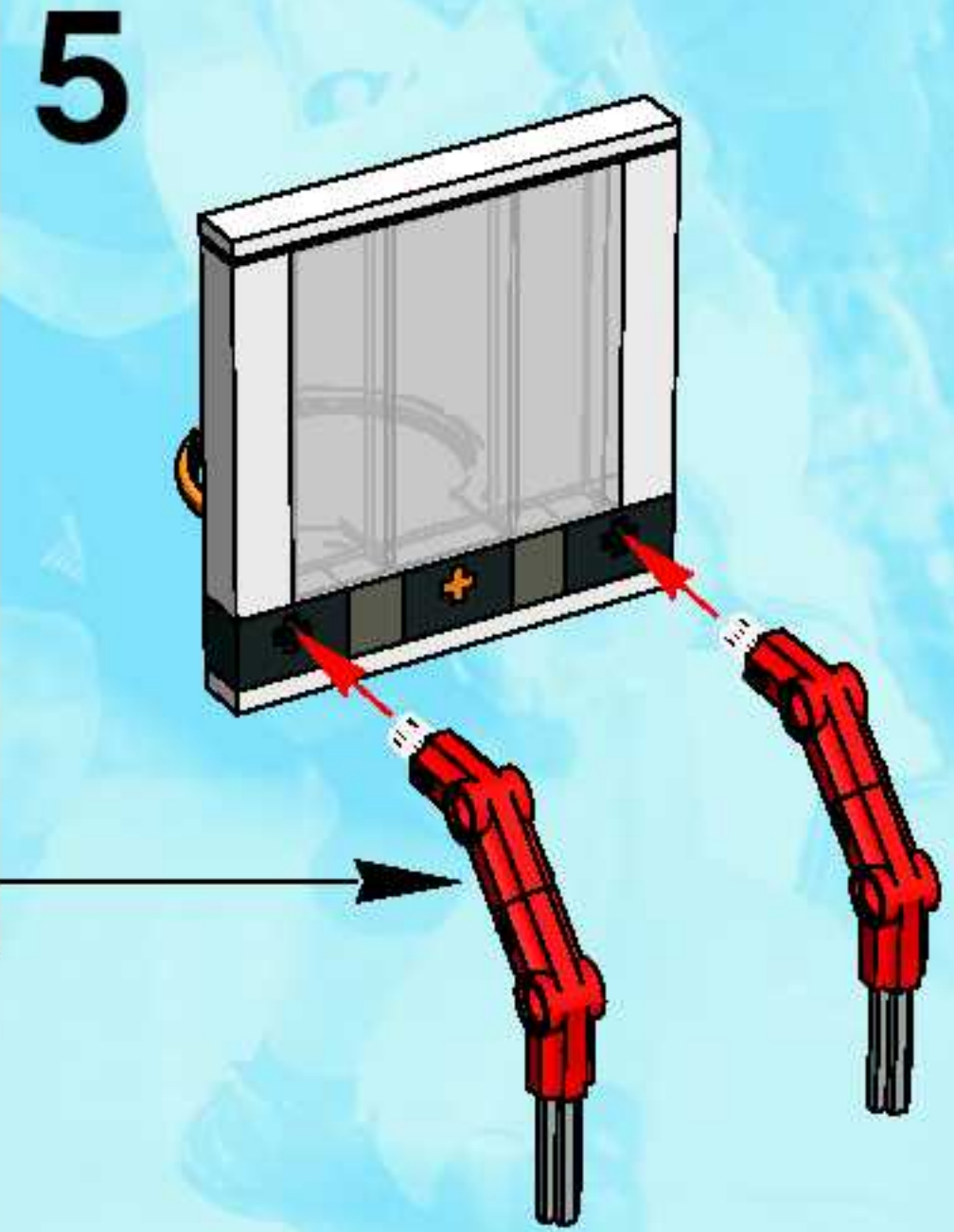
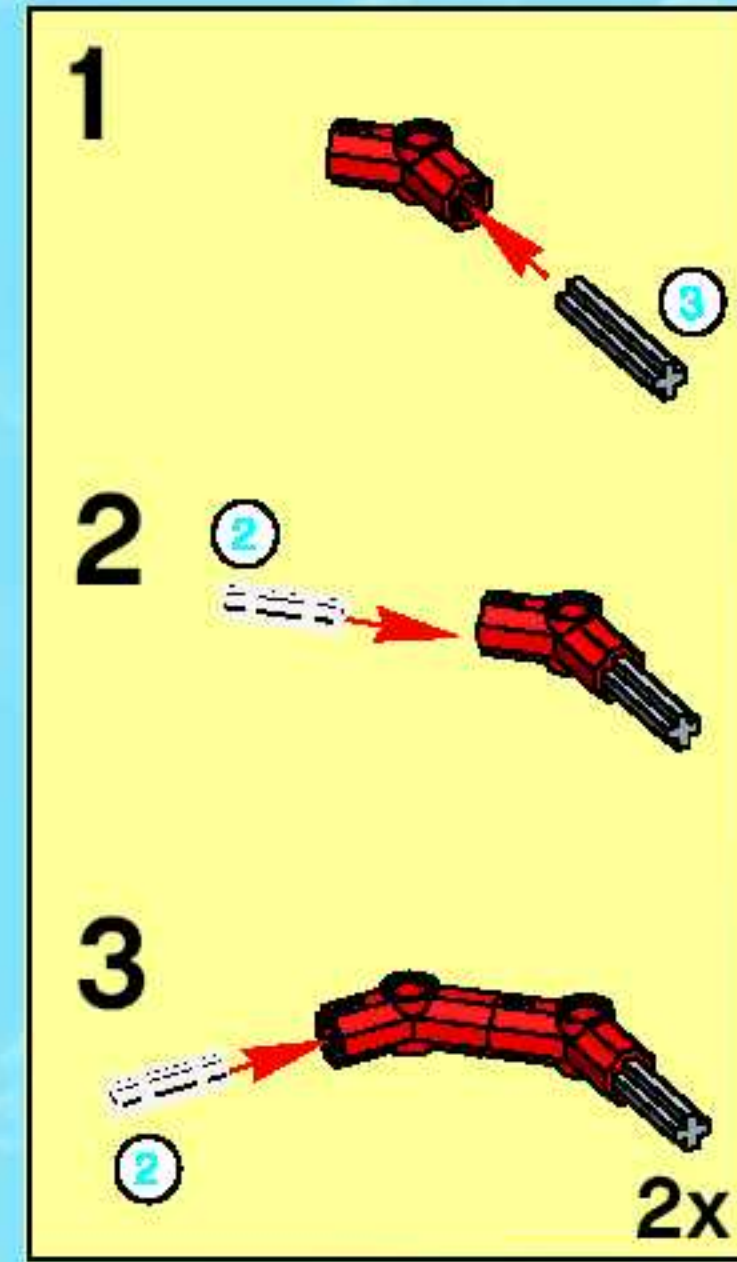
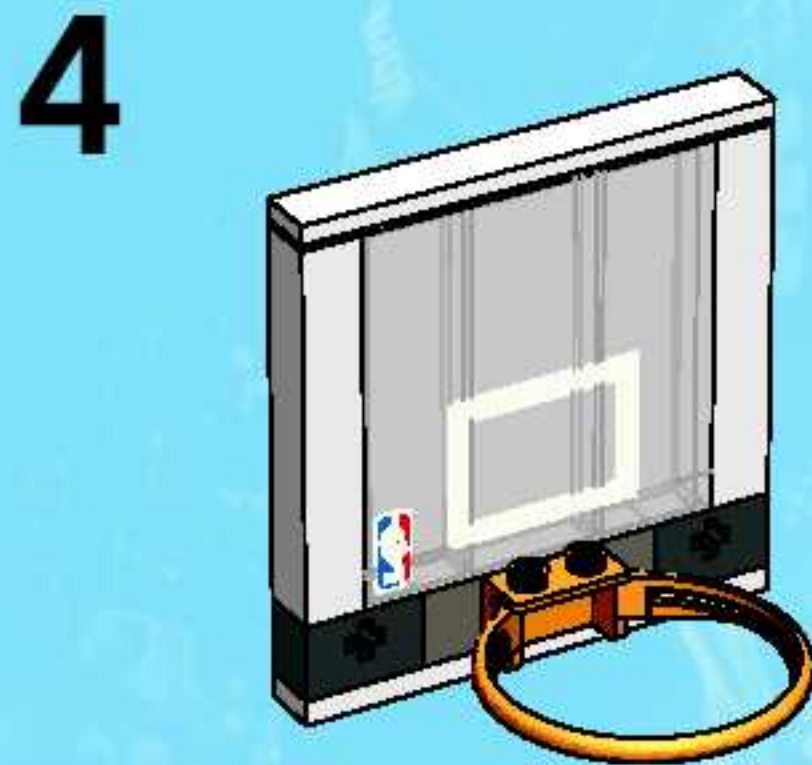
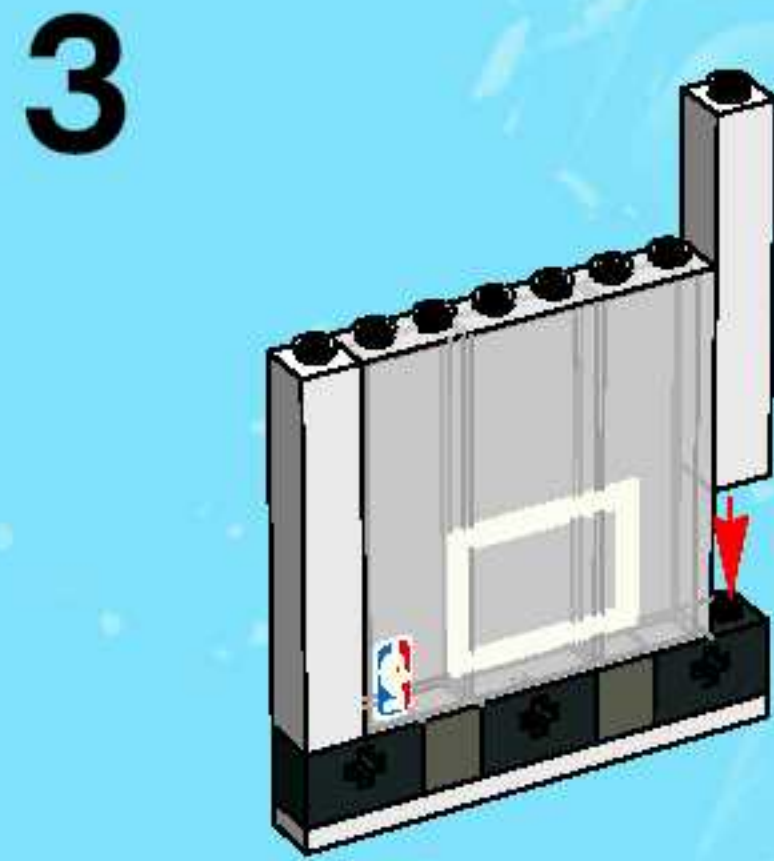
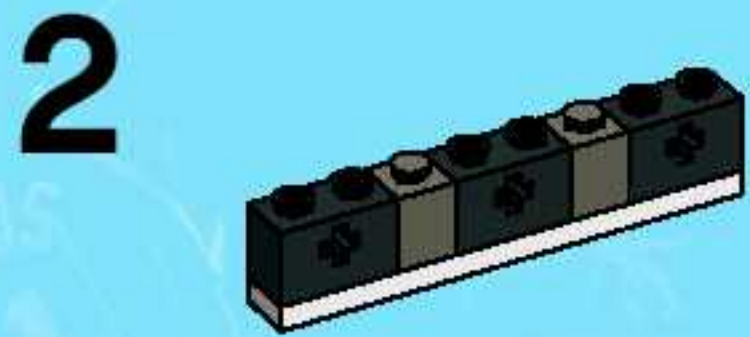
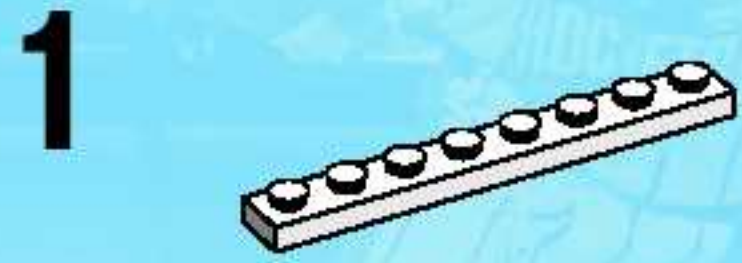

2x

19

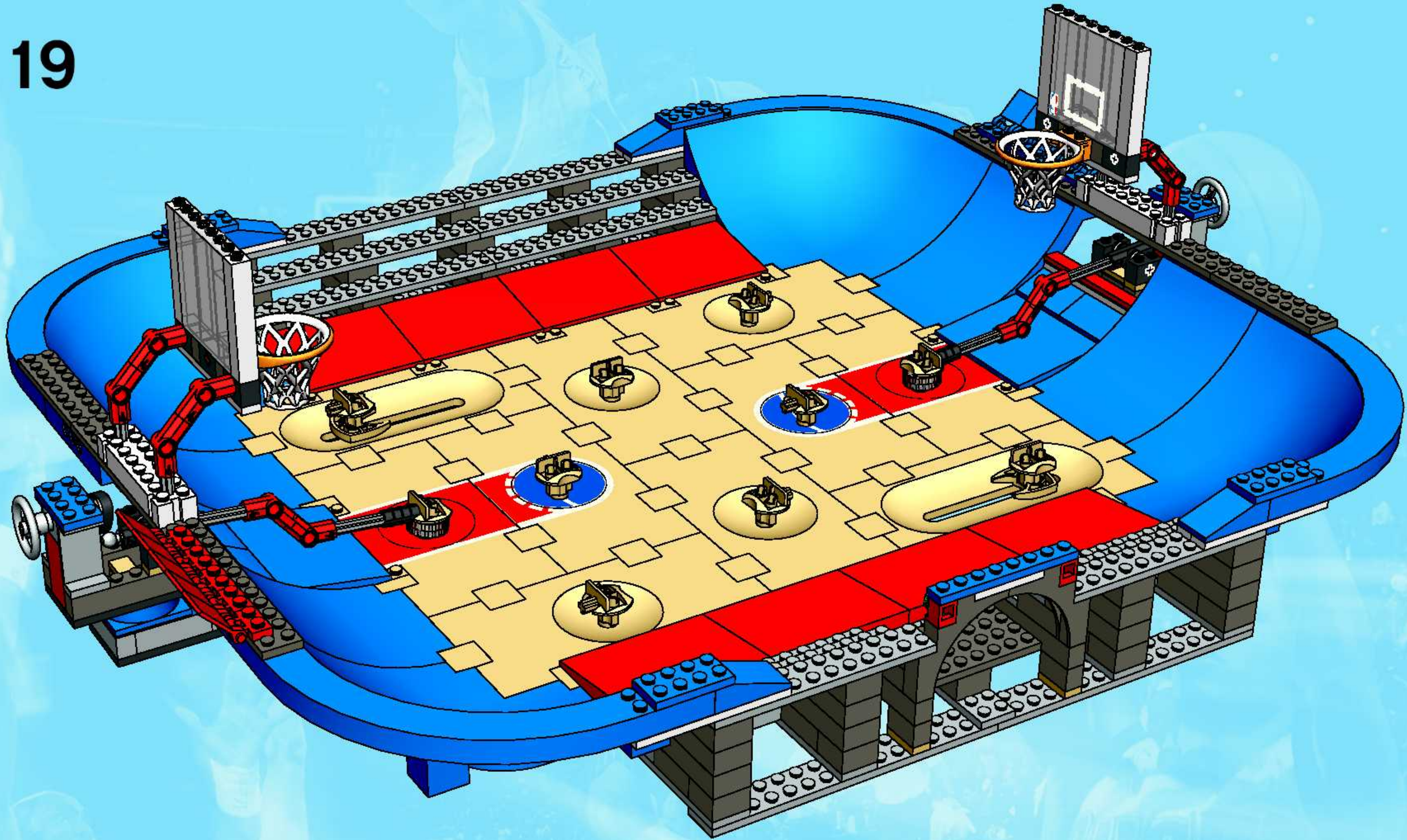

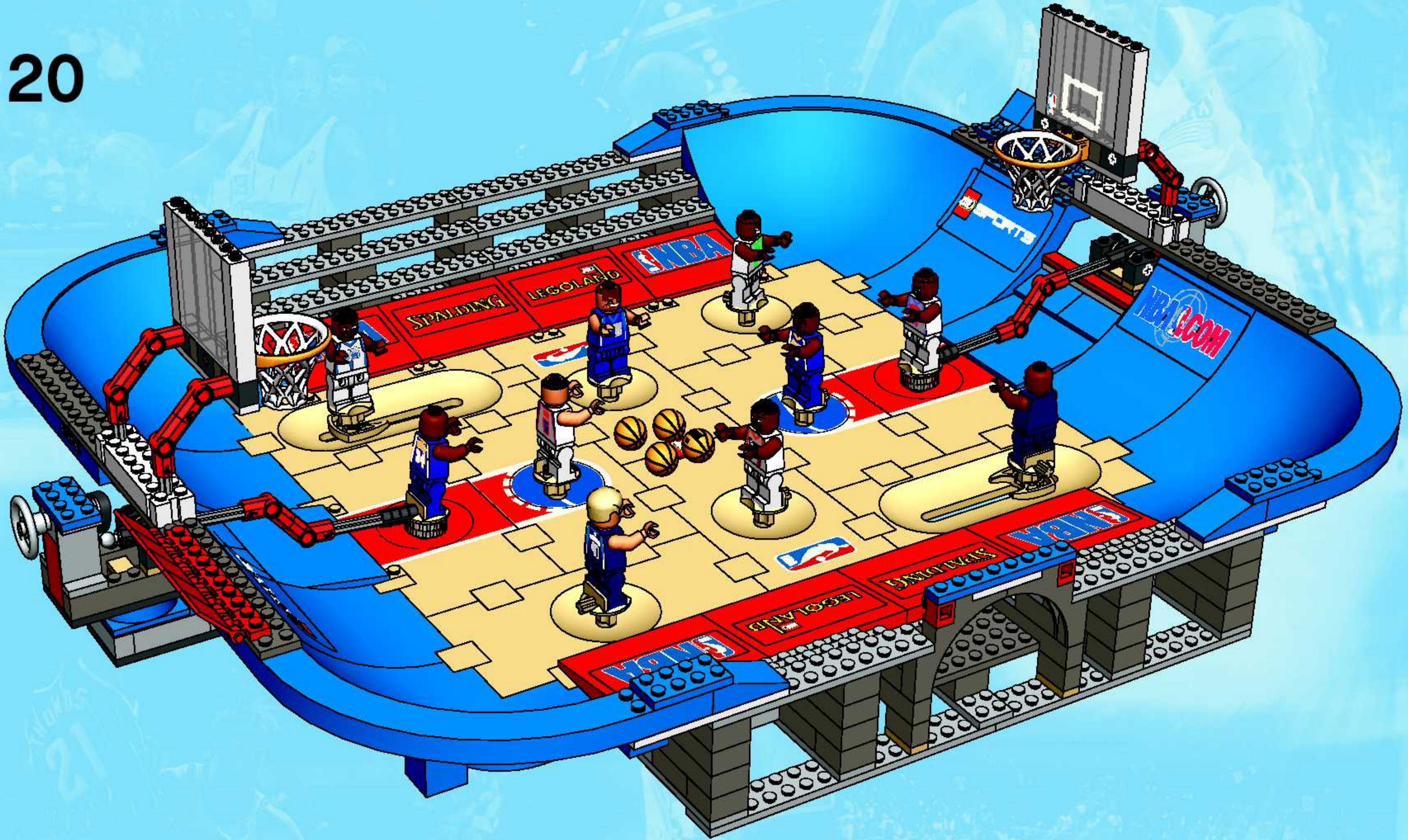



 www.LEGO.com

NBA.COM



 **NBA**





#3428





SPORTS



adidas, the adidas logo and the three stripe trademark are registered trademarks of the adidas-Salomon group, used with permission. Fevernova and the Trigon logo are trademarks of the adidas-Salomon group, used with permission.

adidas, le logo adidas et la marque aux trois bandes sont des marques déposées du groupe adidas-Salomon, utilisées avec sa permission. Fevernova et le logo Trigon sont des marques déposées du groupe adidas-Salomon, utilisées avec sa permission.

adidas, el logotipo adidas y el símbolo de tres bandas son marcas registradas del grupo adidas-Salomon y se utilizan con autorización. Fevernova y el logotipo Trigon son marcas registradas del grupo adidas-Salomon y se utilizan con autorización.



 www.LEGO.com

NBA identifications depicted are the exclusive property of NBA Properties, Inc. and/or the NBA Member Teams, and are used with permission.

Les identifications NBA reproduites sont la propriété exclusive de NBA Properties, Inc. et/ou des équipes membres de la NBA et sont reproduites sous autorisation.

Las identificaciones retratadas de la NBA son propiedad exclusiva de NBA Properties, Inc. y/o de los miembros de los equipos de la NBA, y son usados bajo permiso.

SPALDING is a trademark of/est una marca de commerce de/es una marca registrada de Spalding Sports Worldwide, Inc. or/ou/o Lisco Sports, Inc., a Spalding affiliate/une filiale de Spalding/un afiliado de Spalding. ©Spalding Sports Worldwide, Inc. 2003.

LEGO and the LEGO logo are trademarks of/son des marques de commerce de/son marcas registradas de LEGO Group. ©2003 The LEGO Group.